

MINISTRY OF EDUCATION AND SCIENCE OF UKRAINE

NATIONAL AVIATION UNIVERSITY

Aircraft Continuing Airworthiness Department

ADMIT TO DEFENSE

Head of Department

Candidate of Technical Sciences, Associate Professor

_____ O. V. Popov

" ___ " _____ 2022 г.

DIPLOMA PAPER

(EXPLANATORY NOTE)

OF THE GRADUATE OF THE EDUCATIONAL DEGREE

"MASTER".

Subject: "The method of diagnosing of airframe of aircraft propulsion system".

Conducted: _____ A. O. Maksymov

Supervisor: Doctor of technical sciences, prof. _____ S. G. Ignatovich

Consultant on some sections of the explanatory note:

Labour Safety and Health: Ph.D. in technical sciences, prof. ___ B. I.

Kazanets

Environmental protection: Ph.D. in Biology, associate professor _____

V.D. Savytskiy

Normocontroller:

Kyiv 2022.

NATIONAL AVIATION UNIVERSITY
Aerospace Department
Department of Aviation Engines
Specialty: 272 "Aircraft transport

(code, name)

Educational program: "Maintenance and repair of aircraft and aviation engines

APPROVED

Head of the Department of aircraft engines _____ Y.M. Tereschenko " ____ " _____ 2022

STATEMENT

on performance of the diploma paper

Adam Oleksiyovych Maksymov

(Full name of the graduate)

1. topic of the work "Method of diagnosing the flowing part of an aviation GTE" approved by the order of the Rector on "25" October 2022, # /p.

2. Term of work: from .

3. Initial data of the work. Describe the components and basic characteristics of the typical GTE designs. Learn the basic requirements for the design and features of the GTE turbine operation. Justify the methods of assessing the damageability of GTE parts. To carry out thermodynamic and gas-dynamic calculation of gas turbine engines. Analyze the influence of operating and technological factors on the damageability. Propose decision-making on control actions based on the results of damage parameter monitoring.

4. Contents of the explanatory note: Analysis of GTE operation conditions. Assessment of the impact of GTE operating conditions and their technical state of accumulation

Occupational safety and environmental protection Conclusions. List of sources of information. 5. List of mandatory illustrative material: tables, drawings, diagrams, charts, graphs.

NATIONAL AVIATION UNIVERSITY

Airspace Faculty

Aircraft Continuing Airworthiness Department

Educational Degree "Master"

Speciality 272 "Aviation Transport"

Educational and professional programs "Maintenance and repair of aircraft and aircraft engines"

APPROVED BY

The Head of the Department

Ph.D., associate professor

_____ O.V.Popov

“ _____ ” _____ 2022

Graduation Project Assignment

Maksymov A.O.

1. Topic: "**Gas turbine engine flow path diagnosis method** "

approved by the Rector's order of "25" October 2021 № 2021/CT.

2. Period of accomplishing of the Graduation Project since September 26, 2022 until November 30, 2022.

3. Initial data for the project: searching for data and identifying faults that occur in the hydraulic system and reducing them to maintain the safety of the aircraft.

4. The content of the explanatory note: introduction about activity and principle usage of aircraft and the uses of other systems and units of the aircraft and the large capacity for energy consumption, especially the hydraulic system that provides systems and mechanisms for aircraft management that determine the safety of the flight.

5. The list of mandatory graphic materials: shows the work of the hydraulic, landing gear parts, marking pipeline, the sensor alarm water sludge. Exhaust systems in the aircraft illustrated material is completed with the help of Microsoft Office.

6. Time and Work Schedule

#	Stages of Graduation Project Completion	Stage Completion Dates	Remarks
1	Task receiving, selection of material	01.09.22– 08.09.22	Done
2	Analytical part, detailed analysis of factors influencing on aircraft operational reliability, serviceability	09.09.22-19.09.22	Done
3	Project part	20.09.22-12.11.22	Done
4	Scientific part	27.11.22-12.11.22	Done
5	Labor precautions	28.10.22-12.11.22	Done
6	Ecology	18.10.22-12.11.22	Done
7	Arrangement of explanatory note	28.10.22-12.11.22	Done
8	Preparing for project defend	14.11.22-25.11.22	Done

7. Advisers on individual sections of the project:

Section	Adviser	Date, Signature	
		Assignment Delivered	Assignment Accepted
Labor precaution	Ph.D., associate professor Kazhan K.I.		
Environmental protection	Ph.D., associate professor Pavliuh L.I.		

8. Assignment issue date “ _____ ” _____ 2022.

Degree work supervisor: _____ Iakushenko O.V.
(signature)

Assignment is accepted for fulfillment _____ Maksymov A.O.

ABSTRACT

Explanatory note to the qualification master's work "Method of diagnosing the flow part of aircraft GTE".

91 pp., 27 figures, 7 tables, 24 recommended. literature

In the qualification thesis the research of methods of diagnosing the flowing part of GTE is offered.

The aim of the research is to investigate the methods of diagnosing the flow parts of GTEs.

The object of the research is GTE and parts of the flow part.

The subject of the study is the method of diagnosing the flow part of GTE.

When performing this qualification work used such general scientific methods as: analysis, synthesis, analogy, formalization, abstraction, generalization, observation, description, comparison and mathematical modeling.

In the innovative part of the work, the method of diagnosing the flowing part of GTE is analyzed and suggested.

The standardized methods for determining the corresponding indicators were used in the performance of the sections of health and labor safety and environment.

OPERATION, GTE, TECHNICAL CONDITION, ACCUMULATION, DAMAGE, PART.

CONTENTS

LIST OF ABBREVIATIONS.....	8
INTRODUCTION.....	9
PART 1. Gas turbine engine TV3-117VM.....	11
1.1 Characteristics of the engine TV3-117VM.....	11
1.1.1 Main systems of the engine TV3-117VM.....	13
1.1.2 Main nodes of engine TV3-117VM.....	14
1.2 Compressor of engine TV3-117VM.....	16
1.3 Compressor Pompson.....	20
1.3.1 Operational causes of pumpdown.....	21
1.3.2 Allowable damage standards of compressor stage blades.....	23
1.3.3 Inspection of compressor flow section.....	24
1.4 Conclusions on the section.....	25
PART 2 Diagnostics of the GTE flow part.....	27
2.1 Malfunctions of the flow system operation.....	27
2.2 Algorithms and peculiarities of GTE flow system diagnostics.....	28
2.2.1 Diagnostics of limiting amplitudes of oscillations of GTE compressor blades.....	33
2.2.2 Diagnostics of the stress state of GTE parts by non-destructive methods.....	37
2.3 Peculiarities of diagnosis of the flowing part of GTE.....	39
2.4 Conclusions on the section.....	41
PART 3. Diagnostics of Gas-Turbine Plants and Compressors.....	42
3.1 Absolute pressure sensor capacitive DAE-12S.....	42
3.2 Absolute pressure sensor capacitive DAE-D.....	44
3.3 Thermodynamic calculation of gas turbine engines.....	46
3.3.1 Determination of working body parameters behind the compressor.....	46
3.3.2 Determination of working body parameters at the combustion chamber outlet.....	47

3.3.3 Determination of gas parameters behind the turbine.....	48
3.3.4 Turbodynamic calculation of turbojet two-circuit engines with mixing of flows.....	49
3.3.5 Determination of gas parameters behind the free turbine.....	50
3.3.6 Determination of the main specific parameters of turboshaft engines.....	51
3.4 Diagnostics of the technical condition of the gas pumping unit by thermo-gas- dynamic parameters.....	53
3.4.1 Calculation of normalized diagnostic deviations.....	55
3.4.2 Minimization of influence of the random factor.....	57
3.5 Conclusions on the section.....	62
PART 4. Labor Safety and Health.....	63
PART 5. Environmental protection.....	75
CONCLUSIONS.....	87
RECOMMENDED LITERATURE.....	88

LIST OF ABBREVIATIONS

GTE - gas-turbine engine;

AJR - air-jet engines;

AC -aircraft;

TJE - turbojet engine;

TJEA - turbojet engine with afterburner;

TPE- turboprop engine;

TFE - turbofan engine;

LPC - low-pressure cascade;

HPC - high pressure cascade;

MPD - medium pressure cascade;

GD – guiding device;

OV - operating vane.

INTRODUCTION

Relevance of the topic. Today gas turbine engines are an integral part of life of almost the entire population of the Earth. They are widely used in power plants of different types, aviation (civil and military), shipbuilding, etc. Work on improvement of gas turbine engines in different scientific branches, including development of new metals, is carried out.

One of the main areas of research in aviation metals regarding gas turbine engines is the development of lower weight materials or heat resistant alloys working at critical temperatures for the metal, i.e. above 1050°C.

Particularly acute is the issue of component heat resistance (thermal stability of material parts) operating under conditions that are almost constantly approaching critical temperatures. The reason for this is that the possibility of increasing the temperature at which the components of a gas turbine engine also increases its efficiency and power characteristics.

That is why the fact that the search for ways to improve GTE parameters is indisputably important, and confirms the relevance of the topic.

Relevance of the work lies in the fact that in Ukraine gas turbine engines are widely used. Due to the fact that gas turbine engines are manufactured in our country and are the object of successful export, as well as repaired foreign-made gas turbines (such as aircraft used in the aircraft operated by Ukrainian airlines), there is a need to explore new ways to improve the characteristics of gas turbine engine, which can be used both in the design and in the repair.

The aim of the study is to investigate methods of GTE flow part diagnostics.

The object of the research is GTE and parts of the flow part.

The subject of the research is the method of GTE flow part diagnostics.

The list of tasks, which the author solves in the presented master's work:

- describe the constituent parts and basic characteristics of typical GTE designs;

- to investigate damage accumulation in the turbine parts, which manifests itself during aircraft GTE operation;
- to analyze the ways of GTE turbine blades protection at operation and the ways of their durability increase;
- substantiate the methods of assessing the damageability of GTE parts;
- Describe the general information on PS-90A turbo-jet propulsion system;
- make thermodynamic and gasdynamic calculation of GTE;
- Analyze the influence of operating and technological factors on the damageability;
- propose decision making on control actions based on the results of damage parameters monitoring.

Such general scientific methods as analysis, synthesis, analogy, formalization, abstraction, generalization, observation, description, comparison and mathematical modeling were used during performance of this qualification work.

Part 1.

Gas Turbine Engine TV3-117VM

1.1.1 Characteristics of the TV3-117VM engine

The TV3-117VM engine includes the following structural units and systems:

1. Compressor
2. Combustion chamber
3. Engine turbine
4. Exhaust unit
5. Engine auxiliary drives
6. Lubrication and suspension systems
7. Engine fuel system
8. Engine automatic control system (ATS)
9. Engine start system
10. Air extraction system
11. Engine control and monitoring of engines and their systems.



Figure 1. gas-turbine engine TV3-117

The TV3-117 gas turbine engine has several modifications, which are installed on the helicopters MI-8MT (MI-17), MI-8MTV (MI-17-1V), MI-8AMT (MI-171) and MI-172.

The power plant of helicopters MI-8MTV (MI-8AMT, MI-171, MI-172) consists of two turboshaft engines TV3-117VM and systems that ensure normal operation of engines.

The engine is made according to the twin-shaft scheme, i.e. it consists of a turbo-compressor (TBC) and a free turbine unit (TU), having no mechanical connection with each other. Such a scheme provides the following design and operational advantages:

- allows to reduce the free turbine rotational frequency in comparison with the TBC rotational frequency and thus reduce the mass and dimensions of the gearbox;
- makes it possible to maintain the rotational speed of the NV irrespective of the rotor speed of the TBC, which facilitates helicopter control;
- facilitates the rotation of the TBC rotor when starting the engine;
- eliminates the need for a friction clutch in the helicopter transmission.

The engines are controlled by a unified control system, which allows maintaining the required rotor speed both automatically and manually.

Table 1

Engine type	<i>turboprop, free turbine</i>
Direction of rotation	<i>left</i>
Frequency of rotation of a free turbine	<i>15000 r/min (100 %)</i>
Output power (takeoff mode)	<i>2000 hp</i>
Dry weight	<i>292^{+2%} kg</i>
Length with components and exhaust pipe	<i>2055 mm</i>

Width	660 mm
Height	728 mm

1.1.1 Basic systems of TV3-117VM engine

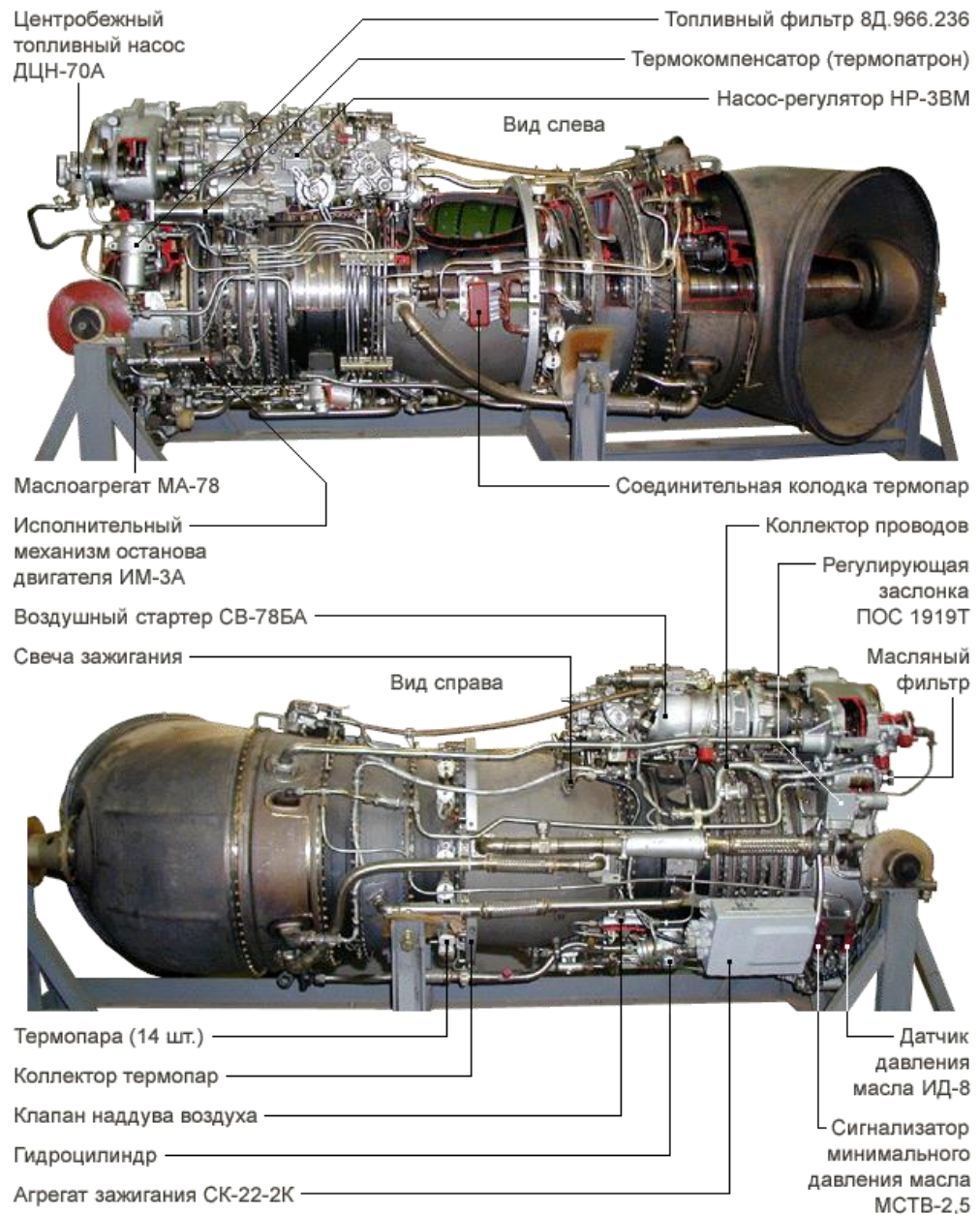

Figure 2. Constructive elements of the TV3-117VM GTE

For reliable operation in all flight modes, at all operating altitudes and speeds, and in all weather conditions the TV3-117VM gas-turbine engine is equipped with all necessary systems:

- - the fuel system serves for feeding the engine with fuel, regulating the engine operation modes, as well as ensuring operation of individual engine control units. The fuel system includes the automatic control system (ACS);

lubrication and suflation system - open circuit, self-contained, single-circuit, circulating, under pressure. Synthetic oil - B-3B (LZ-240 and a number of imported oils) is used;

- air extraction system is intended to prevent icing up of the power plant inlet, dust-protection device operation, ensuring stable engine operation in transient modes, normal operation of engine support seals, as well as to provide helicopter systems with hot air;

- starting system is used to start the engine on the ground and in the air, to perform cold cranking and false starting. The starting system is air-powered, with air withdrawal from the AI-9V air intake system and using an air starter to crank the engine rotor.

1.1.2 Main components of the TV3-117VM engine

Inlet device: smooth channel for air supply from the atmosphere, protected from icing up.

-Compressor: twelve-stage axial.

-Combustion chamber: annular, with 12 fuel nozzles.

-Compressor turbine: two-stage, axial.

The compressor, combustion chamber and compressor turbine form a turbocharger.

-Free turbine: two-stage, axial.

-Exhaust unit: unregulated, expanding.

-Auxiliary drives: provide rotation transmission to the main engine units.

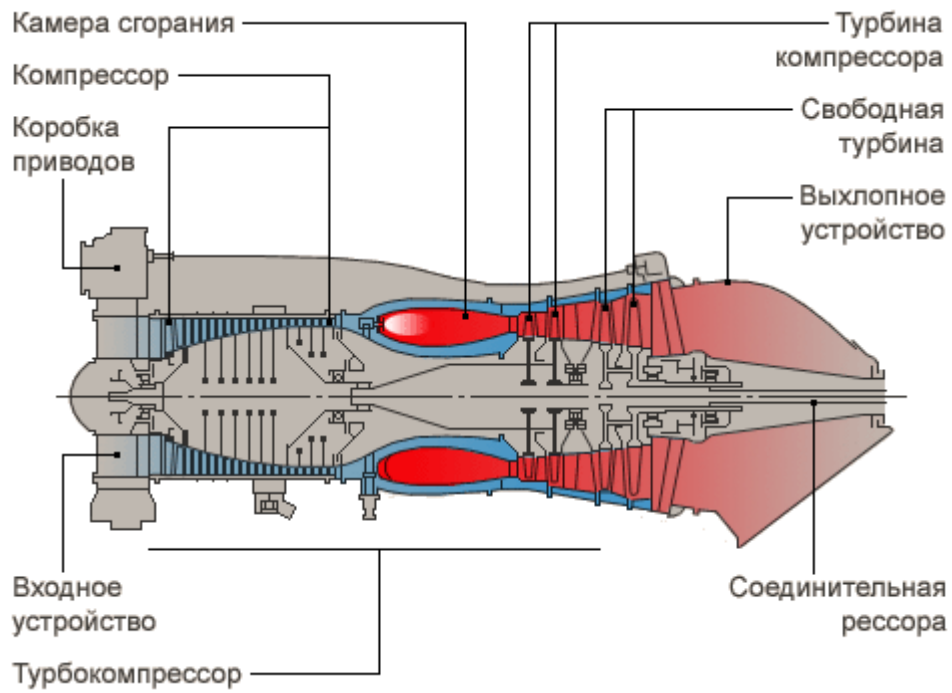

Figure 3. Components of GTE TV3-117VM

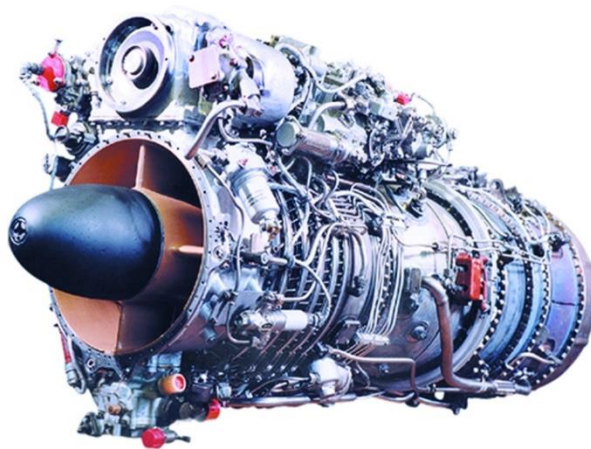
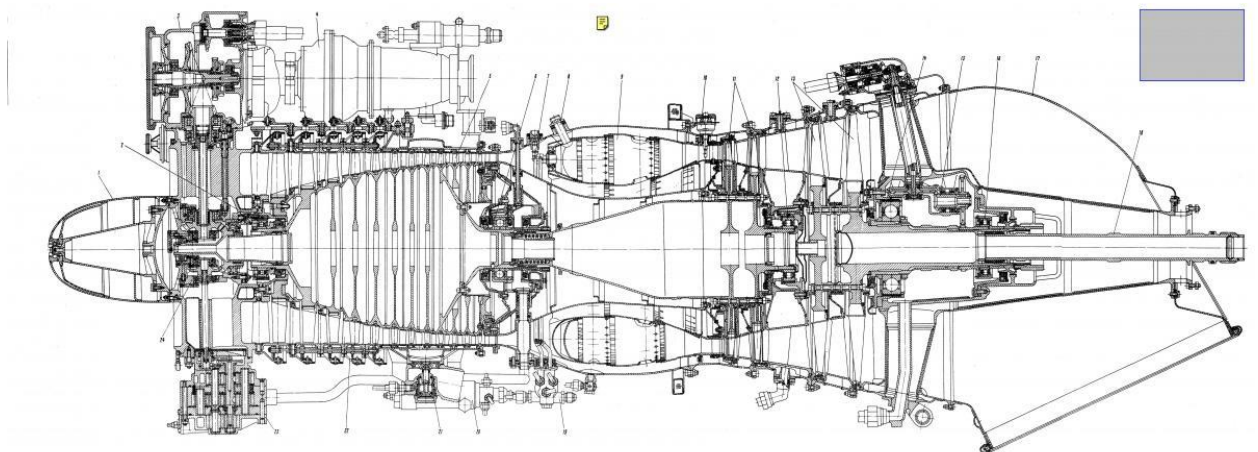

Figure 4. TB3-117VM engine scheme

1.2. Compressor of TV3-117VM engine

The compressor serves to compress the air before it enters the combustion chamber. Air compression and heating at compression contribute to fast and complete combustion of fuel in the combustion chamber.

The engine compressor is axial, subsonic, single-shaft.

Table 2

Number of stages	12
Efficiency	0,855
Pressure rise on takeoff mode	9,45
Mass flow rate	8,85 kg/s
Compressor inlet flow rate	149 m/s
Flow velocity at compressor outlet	112 m/s
Relative mass	0,17

The compressor features rotating blades of the inlet guide vanes (IGV) and guide vanes (GV) of I, II, III and IV stages and two automatically controlled air bypass valves to atmosphere (AAV) due to VII stage.

The compressor has an anti-icing system (AIS), designed to protect the compressor inlet, as well as the air intake (or ROM, if installed) from possible icing. The engine ASR is of the air-thermal type, with use of secondary air from the combustion chamber and with automatic regulation by the thermostat of the sampled air flow rate to reduce power losses at increased operating modes.

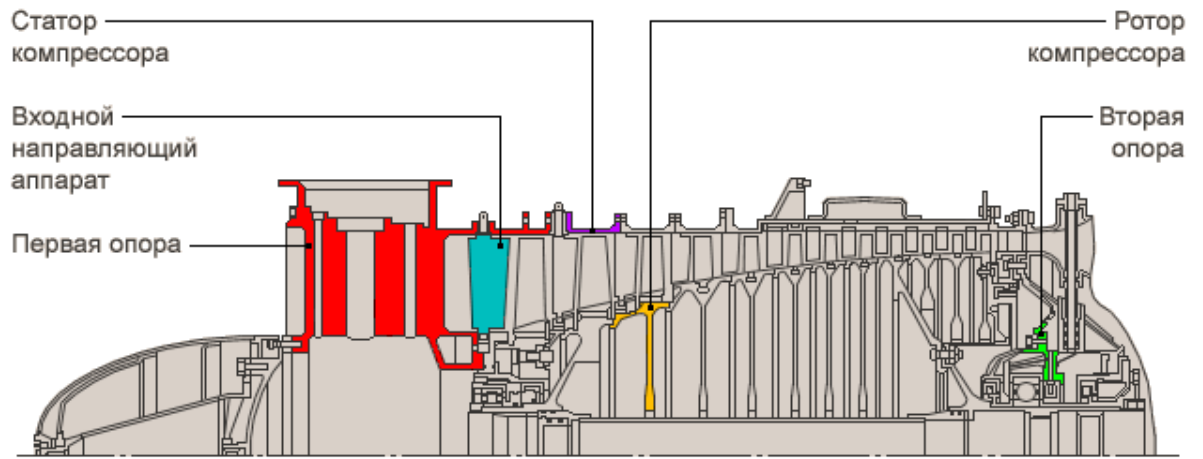

Figure 5. Compressor rotor and supports

The compressor rotor is of drum-and-disc type, with 12 disks and working vanes attached to them.

Compressor front support (the first engine support) consists of: roller bearing, housing with bearing retainer parts, oil nozzles and oil cavity sealing parts.

Rear compressor support (second engine support) includes: ball bearing, housing with bearing retainer parts, nozzle ring and oil cavity sealing parts.

Sufflation of oil cavities of both compressor supports is made through pumping pumps and oil tank. This creates a vacuum in the oil cavities due to the multiple capacity reserves of the evacuation pumps.

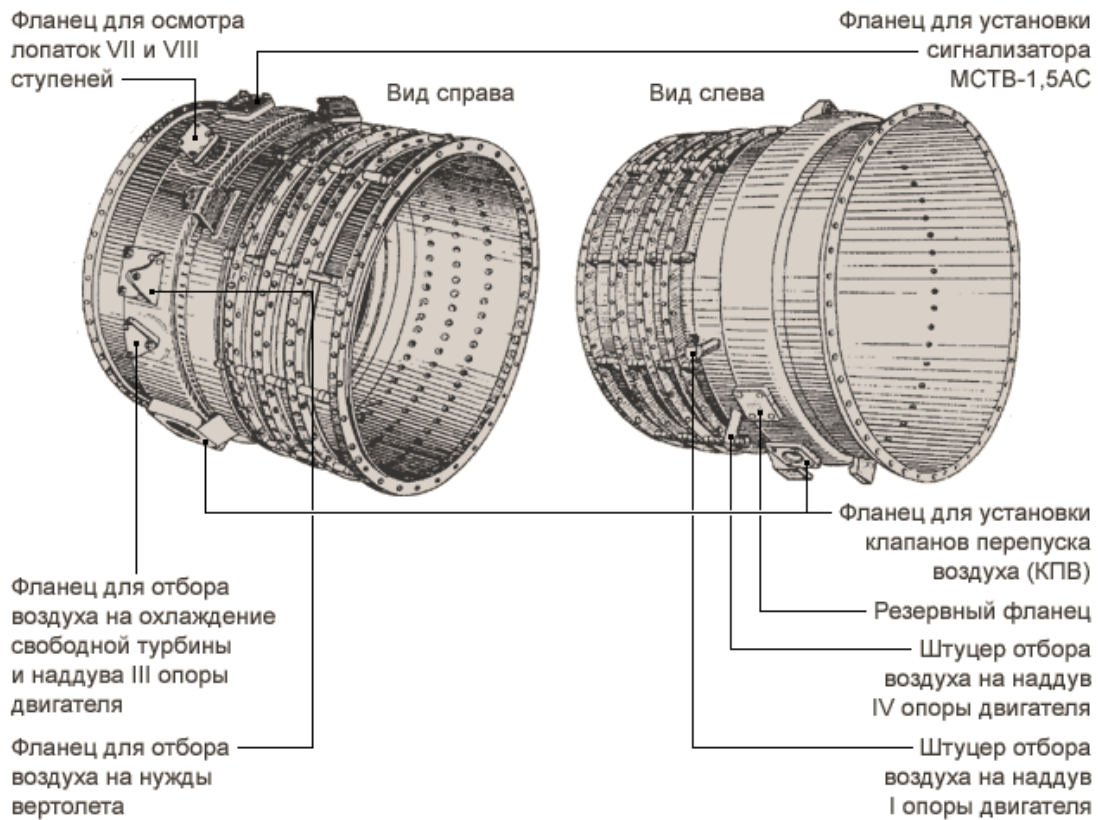

Figure 6. Compressor starter

Compressor stator consists of:

- first support housing;
- front, middle, and rear housings;

Inlet guide apparatus (IGA), and guide and straightener apparatus.

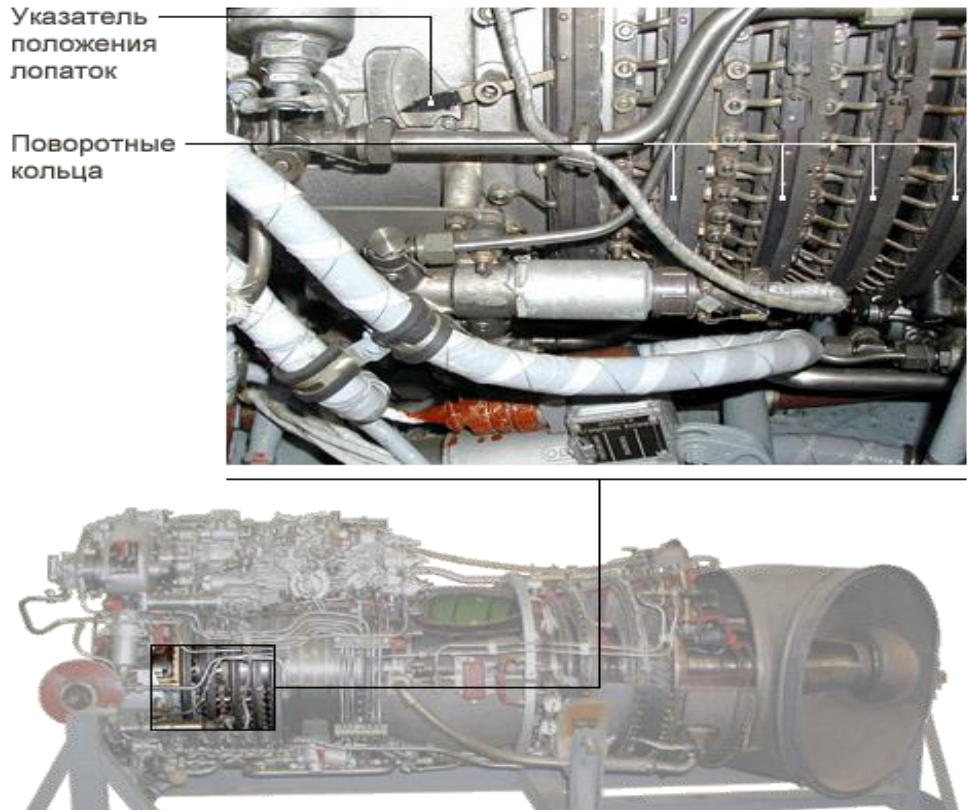

Figure 7: Adjustable VNA and HA blades

The axial compressor is a vane machine in which the mechanical work input from the turbine is converted to air pressure energy.

The compressor stage is the guide vanes (GV) and the impeller (RC). Since the compressor uses subsonic velocities of air flow, the relative velocity (w) decreases and the pressure and temperature increase as it moves in the expanding channels. At the outlet of the impeller, the absolute velocity of the air (c) increases

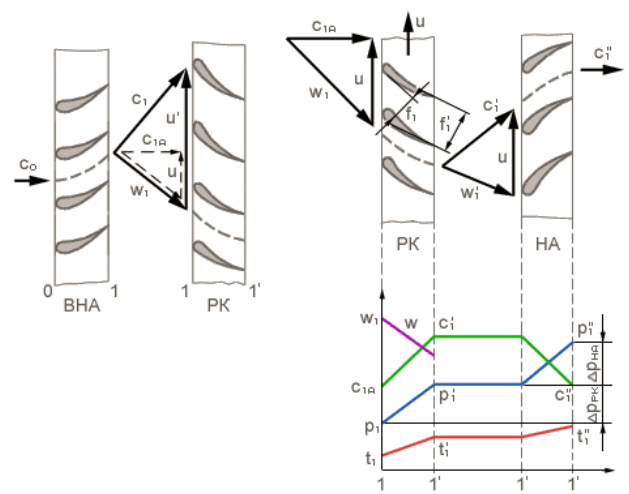

Figure 8. Compressor stage to pressure gain ratio

1.3 Compressor Pompage

The inter-blade channels of all compressor stages are profiled based on the design mode of operation (nominal mode).

When the compressor is operating in off-design mode, air flow parameters (pressure, temperature, velocity and density) in the flow paths change. The passage sections, selected for the rated mode, in this case will not correspond to the new values of air flow parameters, and when changing the angles of flow overhang on the blades, its disruption and formation of whirls are possible. As a rule, these disruption and swirls of flow under unfavorable conditions occur on a part of stages, causing unstable operation, or surge, of the whole compressor.

The greatest influence on the occurrence of surge has a rotor speed. When it decreases compared to the calculated values, the air flow rate, the degree of pressure increase, and the power consumed by the compressor decrease.

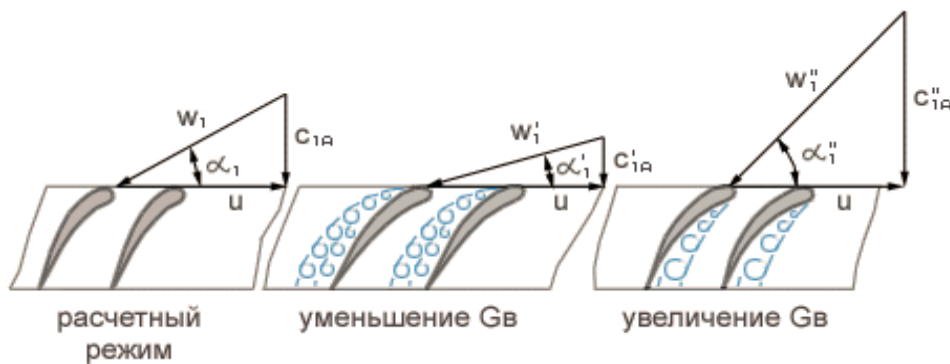

Figure 9. Compressor pompage

Decrease in G_b leads to reduction of axial velocity and flow rupture, which causes occurrence of stall on the first compressor stages. In this case, the last stages can operate in turbine mode or in locking mode.

Flow disruption also occurs at constant speed with a change in air flow G_b , associated with a change in atmospheric conditions or with the peculiarities of the operation and management of the engine. At decrease in the air flow rate stall occurs from backs of blades (locking of the compressor and emission of air into the atmosphere is possible), and at increase - from the side of a trough of blades (such

stall is local and its distribution because of centrifugal forces is unlikely, but the efficiency of the compressor nevertheless decreases).

It is necessary to know: - operational causes of surge; - signs of surge; - consequences of surge.

The compressor of TV3-117VM engine has constructive measures against surge: air bypass valves (ABV) and rotary vanes VNA and HA.

1.3.1 Operational causes of surge

- starting the engine with early starter disconnection;
- engine starting at tailwind or crosswind speed exceeding permissible speed;
- failure or malfunction of compressor mechanisation units (KPV and VNA and HA rotating vanes)
- ingress of foreign particles into engine inlet;
- increased wear and tear of compressor blades;
- helicopter getting into turbulent air flow;
- increase in pitch of the main rotor with incomplete turning of the throttle corrector to the right up to the stop;
- increase in the pitch of the main rotor at a rate exceeding the injectivity;
- starting the PIC on the takeoff mode of the engine.

Signs of surge

- Change of the engine operating tone;
- appearance of claps due to air discharge into the atmosphere;
- fluctuations of gas temperature with a tendency to considerable growth;
- fluctuations of turbocharger rpm;
- increased vibration is possible.

Consequences of pompadour occurrence

- engine power reduction or engine self-shutdown;
- Compressor and power train elements destruction;
- Destruction of turbine components due to high temperatures.

Air bypass valves

To prevent surge starting, two bypass valves are used to partially bypass air from compressor stage VII to the atmosphere. This reduces the flow resistance of the compressor, which increases the flow rate through the first stages and increases the value of the absolute velocity component (c). The relative velocity (w) will be directed at the calculated angle to the blade profile, and there will be no flow disruption from the blades.

Bypassing part of the air from the compressor to the atmosphere causes a decrease in power and an increase in engine fuel consumption. However, this is justified by stable engine operation and reduced power consumption of the starter.

Before start-up the valves are open, at reduced turbocharger rpm 84...87 % the KPVs are closed. The KVPs are controlled automatically from the engine fuel system through the lower hydraulic cylinder.

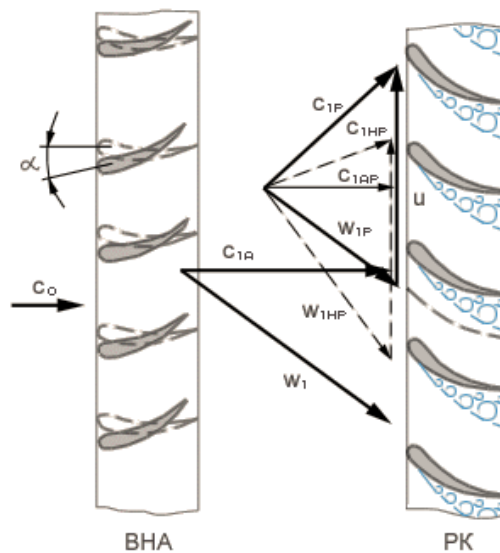

Figure 10. Turning vanes of VNA and HA

The most economical way to protect compressor from surge is to change setting angles of adjustable blades of inlet guide vanes (IAV) and guide vanes (HA) of I-IV stages.

Changing blade installation angles when changing engine operating modes or flight conditions ensures smooth, uninterrupted flow around the working and

guide vanes in a fairly wide rotational speed range. This not only increases the compressor's surge stability margin, but also its efficiency.

At start-up and at low engine operating modes, the blades are covered - the blade angle along the limb is $+27+1.5^\circ$.

At Ntk pr.=81% the blades begin to turn according to a linear law, depending on Ntk rpm.

At Ntk pr. about 104%, the HA blades are set to fully open position (angle = $-6.5\pm 0.5^\circ$).

The blades are automatically controlled by two hydro-mechanisms from the engine hydraulic system.

At present time the wear of the blades of the compressor stage I on the chord is measured with the device U6360-2455. The allowable norms of chord wear are 2 mm for TV3-117VM engines. Note that:

at wear up to 1mm, the frequency of measurement after 100 (50)* hours of flight time;

at wear from 1 to 1,5mm, frequency of measurement in 50 (25)* flight hours; at wear from 1,5 to 2,0mm, frequency of measurement in 25 (10)* flight hours.

1.3.2 Allowed standards of compressor stage blades damage.

In Area 1 (25 mm from the blade tip), it is allowed to have dents and cavities up to 0.5 mm deep and one up to 1.0 mm deep, as well as pinholes on the blade edges up to 0.4 mm deep and one tear up to 1.0 mm with its smooth transition to the blade lip.

In area 2 (from area 1 and 10 mm from the blade root) they allow 0.3 mm depth bumps and dents and three bumps or dents up to 0.5 mm, as well as bumps on the blade edge up to 0.4 mm depth.

No damage is allowed in zone 3 (10 mm from the blade root).

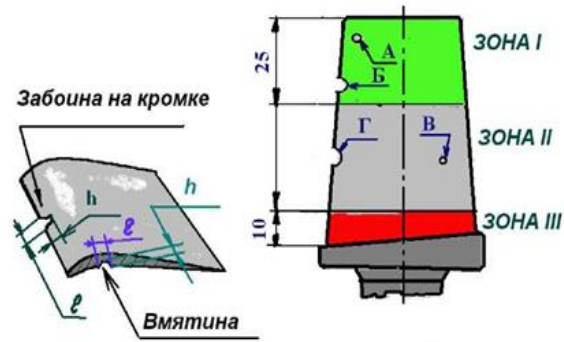

Figure 11. Compressor stage vanes

1.3.3 Inspection of compressor flow section

According to RTO of Mi-8MTV-1 every 300 hours of operation the engine channel section shall be inspected in accordance with TC No.608.

Inspection is carried out both visually and with the use of a set of endoscopes through the inspection windows. The engine shall be inspected:

(a) Using a rigid endoscope:

- inlet guide apparatus (INA);
- working vanes (VV) of the 1st stage of compressor;
- exit edges of the radial vanes of stage VII of the compressor, except for the near-rim part;
- inlet edges of the compressor stage VIII RL, excluding the near-end part;
- 2 blades of guide vanes of compressor stage VII (partially).

b) with application of flexible endoscope:

- inlet guide apparatus (IA);
- working vanes of the 1st stage of the compressor;
- working blades (VB) of VII and VIII stages of the compressor on the whole height;
- 2 blades of guide vanes of compressor stage VII (partially).

Nature of acceptable damages	Maximum allowed size and number of damages
Hole (A) and dent (B) on the working blade in area I.	Maximum depth (H) 0,5 mm and width (L) 0,7 mm on one hole and dent.
holes and dents on the working blade in area II (5 mm from the lock)	Not allowed
Cracks, bends, breaks and tears in the blades	Not allowed

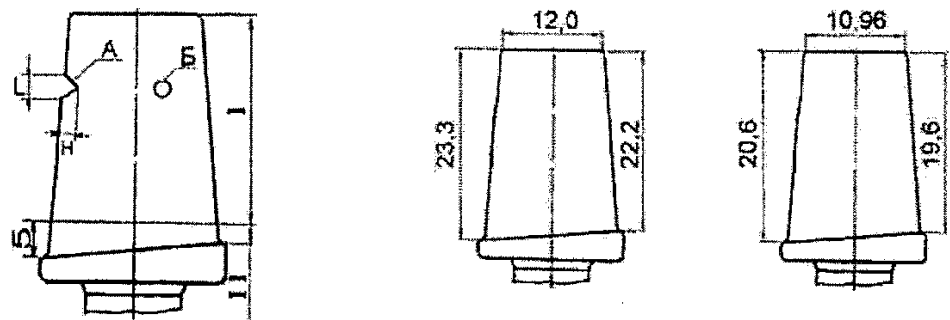

Figure 12. Geometric dimensions of blades VII and VIII of compressor stages.

Blade breaks, bends, tears on the blades, as well as wear of the ends of blades 7 and 8 stages of the compressor more than half the visible width of the blade or the depth of more than two gaps between the end of the non-worn part and the inner surface of the compressor stator are not allowed.

At detection of damages on RL VII and VIII stages, the question of further engine operation is decided by the Supplier's representative in each specific case.

1.4 Conclusions on the part

Gas-turbine engine TV3-117 has several modifications, which are installed on helicopters MI-8MT (MI-17), MI-8MTV (MI-17-1B), MI-8AMT (MI-171), MI-172.

The power plant of helicopters MI-8MTV (MI-8AMT, MI-171, MI-172) consists of two turboshaft engines TV3-117VM and systems that ensure normal operation of engines.

The engine is made according to the twin-shaft scheme, i.e. it consists of a turbocharger (TBC) and a free turbine unit (ST), having no mechanical connection with each other. Such a scheme provides the following design and operational advantages:

- allows to reduce the free turbine rotational frequency in comparison with the TBC rotational frequency and thus reduce the mass and dimensions of the gearbox;
- makes it possible to maintain the rotational speed of the NV irrespective of the rotor speed of the TBC, which facilitates helicopter control;
- facilitates the rotation of the TBK rotor when starting the engine;
- eliminates the need for a friction clutch in the helicopter transmission.

The engines are controlled by a unified control system, allowing you to maintain the desired rotor speed of the main rotor, both automatically and manually.

A compressor compresses air before it enters the combustion chamber. Compression of the air and its heating during compression contributes to fast and complete combustion of fuel in the combustion chamber.

The engine compressor is axial, subsonic, single-shaft. The most economical way to protect the compressor from surge is to change the setting angles of the adjustable blades of the inlet guide vanes (IAV) and guide vanes (DA) of stages I-IV.

According to RTO of Mi-8MTV-1 every 300 hours of operating time it is necessary to inspect flowing part of the engine according to TC № 608.

Inspection is performed both visually and with the use of a set of endoscopes through inspection windows.

PART 2.

Diagnostics of GTE flow system

2.1 Malfunctions of the flow system

Different types of GTE at the stage of their development and operation are characterized by different complexes of defects and flow system state deterioration.

In the process of operation the factors of operation influence on the engine - inrush, discharges, thermal non-stationarity of structural elements, wear of friction pairs, overloading during aircraft evolutions, change of climatic conditions, ingress of foreign objects, etc. The influence of exploitation factors is manifested in the increase of the radial clearances in the blade machines, in wear of associated elements, seals, erosion change of the blade profiles, appearance of backlashes in the HA drive, contamination of elements of the flow part and channels of the cooling system.

Wear of gas generator elements is the main reason for deterioration of gas dynamic parameters of the engine. Typical defects of the flow part are turbine defects - cracks, burnouts of separate nozzle and working blades, erosive wear of working blade faces.

Among other failures are damage of compressor blades due to foreign objects, erosion wear, burn-out of nozzles and compressor system flame pipes, air leakage through the compressor and compressor system flange joints in the places where pipes, valves, plugs are fastened, turbine joints are opened.

Ideally, for full-fledged diagnostics of the GTE flow path it is required to measure flow parameters (pressure and temperature) in all characteristic sections: at engine inlet and outlet, at inlet and outlet of each compressor and turbine cascade. In practice, the list of measured parameters is much smaller, although there is a tendency to expand it. Most often on modern engines, air pressure and temperature are measured at the engine inlet, behind the compressor and behind the turbine. Obligatory for measurement are rotor speeds, as well as parameters, characterizing changes of regulated elements of GTE mechanization, size of air intake for the needs

of anti-icing system and air conditioning system of the aircraft. The majority of the mentioned parameters take part in the engine regulation and this is the main reason of their application.

The gas temperature behind the propulsion system is a "complex" parameter in terms of sensitivity to the condition of the flow part. An increase in sensitivity can be caused by various reasons - increased leakage in the RHA, deterioration of compressor and turbine performance. The air temperature under the gas generator panels can detect hot air leaks from the IAC. The change in high-pressure compressor performance is indicated by the character of the air temperature change after the RHA.

2.2 Algorithms and peculiarities of diagnostics of GTE flow part

At the present time the processes occurring in GTE are well enough studied. In general case they can be described by non-linear equations system, linking state parameters (pressure loss coefficients, units efficiency coefficients, areas of flowing sections, gas and air leakage values) and measured parameters (pressures and air and gas temperatures in different sections, rotor rotation frequency, fuel consumption, thrust).

The development (smooth or jump-like) of a defect is usually caused by the change of nodes characteristics that are not available for measurement, but it is manifested directly in the drift of the measured thermo-gas-dynamic parameters. Connection between measured parameters and node characteristics is described by thermos-gasdynamic mathematical models of different levels of complexity.

All the defect detection methods use these models.

Methods of detecting defects in the flowing part can be classified into two main types:

-defect detection based on measured parameter analysis;

-detection of defects based on the identification of thermo-gas-dynamic model, with subsequent recognition of defects based on the analysis of the parameters of the characteristics of the components.

Selection of the best type for practical implementation depends on the current stage of the gas turbine engine life cycle. As the service life increases and empirical information about the engine condition accumulates, the advantages of the first direction methods increase. These methods additionally provide good visibility when performing expert analysis on a group of diagnostics objects and at the regression analysis of time series.

As a rule, at application of methods of the first kind, the reduction of values of parameters to standard atmospheric conditions and to the settlement mode is performed.

At use of the second type, the so-called "unrelatedness" of parameters or characteristics of units is used more often. For the given external conditions and engine operation mode by means of a mathematical model (model identification), parameter values are calculated for various defects and the difference of the current values of the parameters. The obtained differences represent "deviations" of parameters. The minimum "discrepancies" are obtained for the state that corresponds to the most probable defect specified in the model. The method relies on model identification and enumeration of possible defects of small multiplicity.

The decision on the particular type of GTE state is made according to the principle of minimum "nonconvexity". With the positive properties of the method, the significant disadvantages of the method include low visibility when performing expert analysis on a group of diagnostic objects and especially during the analysis of time series.

Permissible values of changes in the characteristics of the diagnosed units are assigned according to the statistics obtained from tests and operation of engines, which had defects and worked out their service life without defects.

In the process of parameter analysis under operating conditions there is an influence of random factors on calculation results:

- changes in air withdrawal or power to the aircraft;
- errors of measurement and registration of parameters;
- The error in maintaining the engine operation mode by the control system.
- unevenness of air flow at the inlet engine;
- variations in load of drive units;
- process variations of geometric dimensions, characteristics of nodes in the manufacture of engines;
- wear of parts during operation;
- humidity, air turbulence, wind direction and speed.

Automated GTE diagnosis systems traditionally use algorithms of identification of mathematical models to determine flow part failures and algorithms of trend analysis to identify trends of measured parameters changes in time. Identification of a mathematical model consists in determination of discrepancy between measured and calculated values of parameters. Application of the trend-analysis procedure to the deviations of the parameters from the calculated ones makes it possible to reveal the regularities of their change over the operating time against the background of random measurement errors.

At relatively low frequency of information registration by onboard registration systems, taking into account high inertia of channels of measurement of separate engine parameters, it is difficult to provide diagnostics of a state of a flowing part on variable modes of engine operation. The steady-state modes of engine operation should be recognized as the most acceptable for diagnostics of a flowing part of GTE. General requirements to the choice of diagnosing modes can be formulated as follows:

- the engine operating mode should be high enough to distinguish changes in parameters caused by changes in the state of the flow part from changes caused by random factors.

-parameter measurements should be influenced by the least number of random unmeasurable factors by selecting modes with the maximum similarity of external conditions and mode parameters.

In the takeoff mode the engine has the highest possible values of parameters, which contributes to the reduction of the measurement error. However, there are difficulties in ensuring similarity of conditions due to the processes of heating of massive rotor parts, closing of valves, change of speed of the aircraft, etc. In conditions of climbing the engine is warmed up and measurements of its parameters are subject to the influence of the least number of random unmeasured factors at a sufficiently high absolute level of measured parameters. The cruising flight mode takes place under minimum turbulence conditions.

The optimum time of formation and the sizes of samples for determination of values of parameters are chosen proceeding from features of the registered information of the engine, and also duration of course of processes in the engine.

In practice, the term "reference point" is widely enough used to indicate both a certain steady-state mode and the averaged value of the parameter calculated from a sample of values. To exclude the influence of meteorological conditions on the value of GTE parameters under control, it is required to meet standard atmospheric conditions (ISA). To reduce the influence of errors in the reduction, this procedure should be performed with respect to standard atmospheric conditions corresponding to the selected reference points. The reduction of parameters to ISA is performed according to standard gas-dynamic formulas of reduction, to temperature and pressure corresponding to ISA of the reference point of this type. Obtained after the procedure of reduction values of parameters in the reference point of one type relate to close, but in general different modes, so to ensure the comparability of values of parameters it is necessary to perform the procedure of reduction to the calculated mode.

In order to create this procedure, it is necessary to create this procedure:

- to identify the type of functional dependence, sufficiently accurately describing the change in the parameter on the mode parameter;

- determine how the type of this dependence changes from engine to engine;
- to define conformity between real dependence and the dependence received by means of mathematical model of the engine;
- to define character of change of functional dependence at increase of an operating time of the engine (parallel displacement or a turn); - to define character of influence of size of air take-off, position of elements of mechanization of the compressor, etc.

Consecutive application of the method of bringing parameter values first to standard atmospheric conditions, and then to the calculated mode, allows plotting the dependences of parameter changes on the operating time. Graphs of these dependences are a useful tool to provide a clear visual reproduction of parameter displacements or long-term trends.

This opens up the possibility of performing flow condition diagnostics by analyzing time series. The simplest, yet most reliable, method of analysis is to determine the baseline values of the parameters from the initial period of operation and then monitor the deviations of the reduced values of the parameters from the baseline.

There is a method of electrostatic diagnostics (electrostatic probing) of GTE gas-air duct. The method is based on registration of potential difference, arising between the sensitive element of the electrostatic sensor and the GTE body as a result of carrying of charged particles by the gas flow, formed at burnouts and failures of structural elements, erosion wear of the gas path, particles of condensed phase of fuel combustion products, and also sand and water particles.

The method under consideration is the only practically realized method of revealing the initial stage of the process of destruction of elements of flow parts of working aircraft GTEs, rocket engines and other heat and power installations in real time. Abroad (in the USA), the method is a standard one for helicopter IC diagnostics. For example, occurrence of crack on working blade of compressor does not lead to change of gas-dynamic and vibration parameters, which can be detected by method of parametric diagnostics. But the development of the crack will lead to

the breakage of the blade, which will cause significant secondary damage to the flow part and, as a consequence, to a significant increase in the cost of repair. Crack detection by electrostatic method will allow to stop the engine in time and during repair replace only the blade with a crack.

The electrostatic method allows predicting a large group of such failures, which were previously considered unpredictable, as well as almost all failures, which can be predicted by traditional methods of analysis of trends in GTE flow part parameters - trend analysis.

Realization of the electrostatic method of diagnostics at test and GTE operation allows creating the automated system of detection and registration of solid and liquid disperse particles in gas in real time that provides improvement of maintenance and repair of engines, definition of borders of working capacity and pre-emergency condition at GTE operation.

As sensors in different sections of the engine, capacitive sensors can be applied both with screens for the central electrodes, which increase the efficiency of operation of GTEs.

The capacitive sensors can be used as sensors in different sections of the engine, with and without the screens of central electrodes increasing the sensors efficiency [12.3.9.30]. At the motor inlet and outlet, integral sensors can be installed, which are circular electrode structures or circular structures with a mesh electrode, covering the entire area of the corresponding cross-sections.

Fig. 12.3.6.2.5_1 shows the scheme of possible installation of electrostatic diagnostic sensors in the GTE flow part. It is advisable to install sensors in each of six specified sections.

2.2.1 Diagnostics of limiting amplitudes of GTE compressor blades oscillations

Operation on the technical condition of aviation GTEs, land-based GTUs and other turbomachines indicates the high relevance of application of methods and

diagnostic tools that provide operational information to assess the actual state of the object and its monitoring - prediction of technical condition in order to determine the trend and make the necessary decisions when detecting pre-emergency conditions. For these purposes, a non-contact discrete-phase method (DPM) and appropriate equipment for recording and processing of diagnostic results can be used.

The measuring scheme in a classical version of a DPM is shown on Fig. 2. The following designations are used here:

- ÄÎ - reverse sensor,
- ÄÊ - root sensor,
- ÄÏ - peripheral sensor,
- NÐ - rotor speed of the turbomachine,
- K -root exciter ledges with angular root projections-exciters with angular pitch of working blades tē on a specially mounted ring in the rotor,
- O -reversible overhang,
- 2ÀÌÀÕ -swing range of blades' ends
- l - length of bright line,
- CSG -constant sweep generator of horizontal electrodes electron-beam tube (EBT) plates, triggered by a pulse signal from the revolving sensor DÎ,
- GWR-generator of the CRT 1 vertical plate-electrode standby scanning, triggered from the pulse signal from the root sensor DK,
- M-modulator that gives backlighting of the CRT beam from the pulse signal from the peripheral sensor

As a result of rotation of the wheel with blades on the vertical lines of the CRT a set of bright dots appears, which is converted into a bright mark as a result of the screen afterglow.

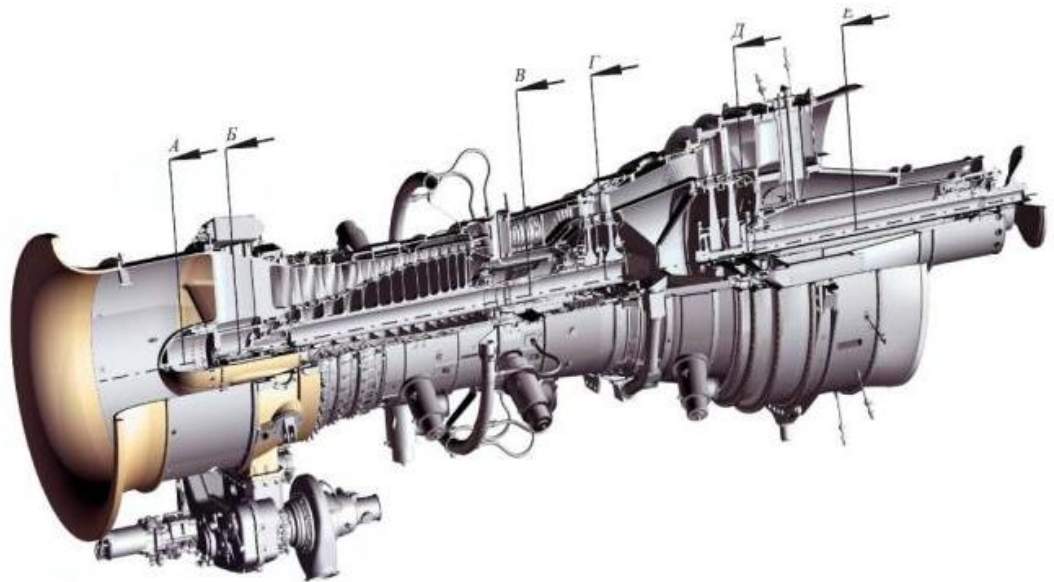

Figure 13 Scheme of possible installation of electrostatic diagnostic sensors in the flow part of PS-90GP-1 engine for GTU

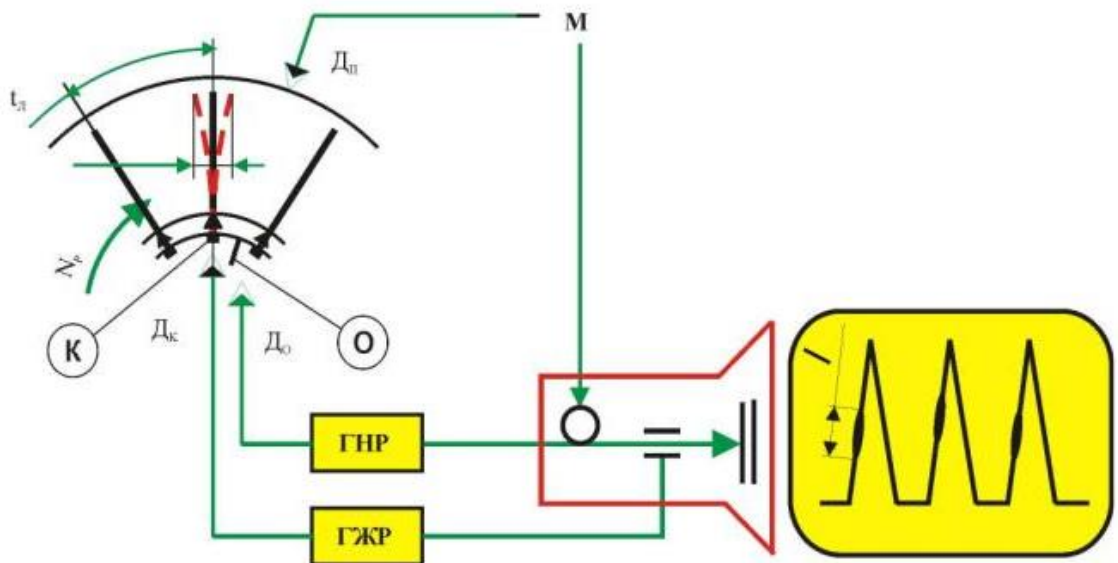

Fig. 14 Schematic diagram of the classical method of DPM implementation 1 - CRT; 2 - CRT screen with the signal image

At work of GTE on the CRT screen 2 there are vertical lines by the number of working blades of the investigated stage of the compressor with bright marks of different length corresponding to the oscillations range of the particular blade end.

However, the reliable estimation of the maximum permissible values of amplitudes of oscillating blades in operation for application of the classical method of DPM, as a rule, is connected with big technical difficulties, caused by rework of stator part at partial or full disassembly of GTE, use of difficult technological tooling and big money expenditures. All this to a large extent restrains the wide application of the classical version of DPM.

There is a fundamentally new method, based on DPM, quite simply and effectively solving the actual problem of non-contact diagnostics of the limiting vibrations of GTE compressor blades in operation. The new method of measurement of vibration parameters of blades [12.3.9.32] allows, using only one peripheral impulse sensor to obtain reliable information about vibration amplitudes and thus about the most dangerous stresses in the root section for all working blades of any turbomachine stage, vibrating according to bending or torsional vibration forms with amplitudes not less than 0.25 mm. The essence of the method consists in replacing signals from reverse and root sensors by pulses from special electronic devices (pulse generators), acting as electronic sensors (quasi-sensors) and processing these signals according to a special algorithm using a computer module program. These pulses are synchronized with rotation of the rotor and the number of blades in the investigated stage. For practical implementation of the proposed method, pulse sensors of inductive or capacitive type are installed in the compressor body outside over the ends of working blades of one or several stages, depending on the material of the blades. The main problems are generally related to the durability and noise immunity of the pulse sensors. To avoid these problems, it is recommended to use induction sensors of DO-5 type, used in rocket technology, as induction sensors, and capacitive sensors based on aircraft spark plugs of SD-96 type with standard contact devices. The experience of using pulse sensors of these types for non-contact measurements of vibrations of GTE working blades showed their sufficient immunity to interference and the required durability.

2.2.2 Diagnosing of stressed state of GTE parts by non-destructive methods

Determination of values of installation and technological residual stresses in critical parts of GTE (disks and blades of magnetic materials, shafts, gears, bearings) by non-destructive methods of diagnostics is an actual problem for operation. One of such methods is currently based on the Barkhausen effect, a magnetic-noise method, which allows estimating the magnitude and sign of stresses in the surface of magnetic materials by the spectrum of the noise signal. In special literature, as well as in Russian standards, this method is classified as the Barkhausen effect method (MEB), named after the German scientist, the discoverer of this phenomenon.

The effect consists in obtaining, through a special sensor, a noise spectrum from a magnetic material when subjected to a pulsed electromagnetic field. From the noise spectrum with the appropriate calibration, it is possible to obtain information about the parameters of the surface after thermomechanical treatment and hardening: hardness, degree of hardening, magnitude and sign of the residual stresses and other parameters.

Presently in our country and abroad research works on practical use of MEB are conducted, as measuring of stresses by this method enables to determine their values in the surface of important gas-turbine engine parts without destroying them. The method is hardware implemented in the USA, where ROLLSCAN-200-3 system is serially produced for measuring magnetic parameters and processing the obtained data on stress values (see Fig. 12.3.6.2.5_3).

It is known from the experience of MEB application [12.3.9.33] that the most time-consuming and responsible stage of determining the voltage values is the calibration of the measuring system. This requires special samples made of materials similar to shaft materials, having surfaces identical to those of the shafts. The accuracy of the measurements ultimately depends directly on the quality and accuracy of the calibration, taking into account the good sensitivity of the method.

Instrument calibration should be performed on samples cut out of the object under study, preserving the surface layer and shape of the surface of the part under study.

By means of MEB it is possible to detect defects of mechanical treatment, for example, burnt at grinding, non-uniform hardening at shot blasting, to estimate the quality of electrochemical treatment and welding, the locations of local tensile or inadmissible compressive stresses in the bearing cages, zones of plastic deformation of material, for example, in parts and units of GTE under load.

To determine stresses in non-magnetic materials in operation, the operating principle is used. X-ray structural method consists in obtaining information about the change in the angle of inclination of crystal lattice axis of the material under the action of load. Information is registered by detector of "soft" X-rays reflected from surface layers of material up to 40 μm deep. Portable XSTRESS-3000 type apparatus for X-ray structural measurements is shown in Figure 12.3.6.2.5_4.

Goniometer 1 is a device having an X-ray emitter and a receiver of the signal reflected from the surface layers (40 μm depth) of the object. The apparatus includes a high voltage source 2 and a portable computer 3.

The equipment can be used to make resource forecasts. A comparative assessment of measured stress values in critical GTE parts using the Barkhausen effect and the X-ray method with the XSTRESS-3000 apparatus gives satisfactory results.

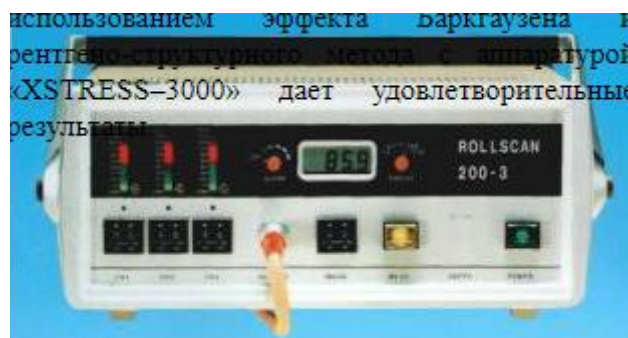

Figure 15. General view of the ROLLSCAN-200-3 hardware

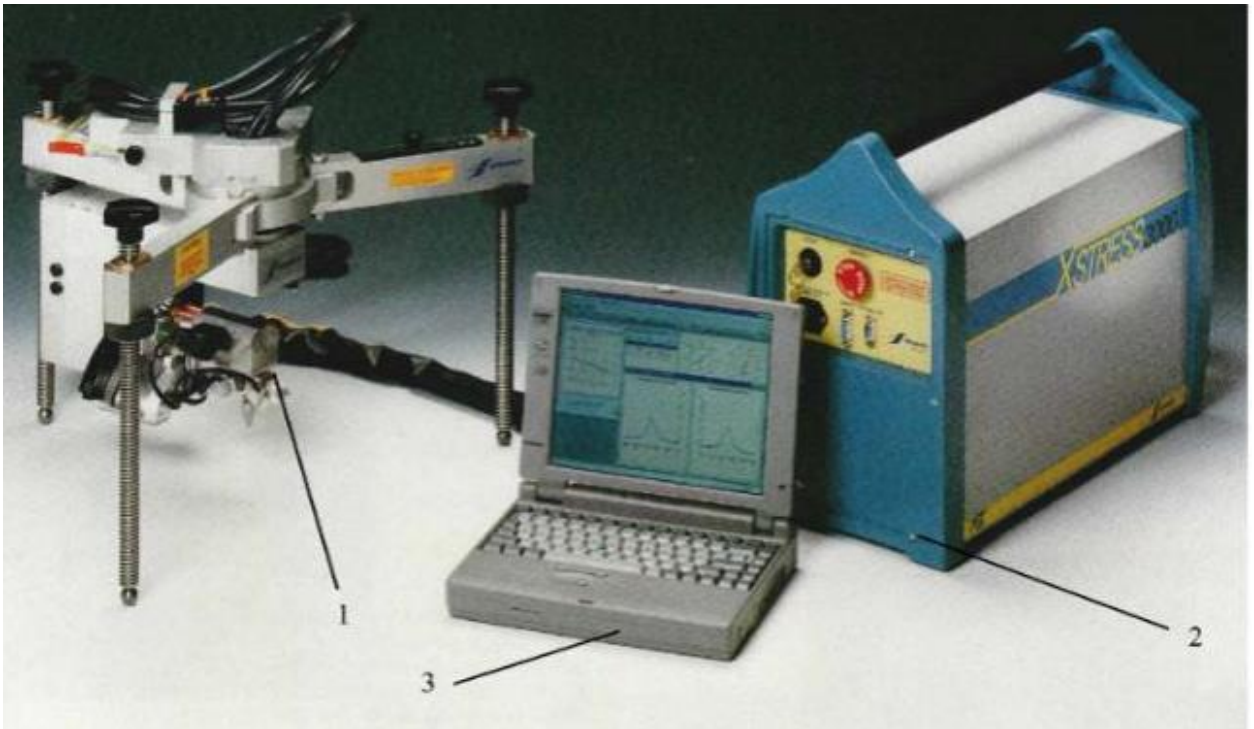

Figure 16: General view of XSTRESS-3000 apparatus

1 - portable goniometer; 2 - high voltage source;

3 - laptop computer

2.3 Peculiarities of diagnosis of the GTE flow part

Peculiarities of diagnosis of GTE flow path are connected, first of all, with influence of parameters of the supercharger on GTE parameters, possibilities of analysis of temperature field behind the turbine, measurement of gas parameters between turbines, use of measured electric power of electric generator as a mode parameter, application of periodical processing instead of processing of completed flight. The mentioned peculiarities affect the diagnostic algorithms, although the basic principles remain the same as for aviation GTEs.

Analysis of flow part parameters is performed at dynamic and static (steady-state) modes of GTE operation. Dynamic modes include starting, stopping and changing the set mode. Static modes are operation at minimum mode, "in ring" (without gas pumping in the main line), at operating modes. Steady-state modes prevail at operation of GTE in main gas pipelines and at power plants providing

technological needs of enterprises. Start-up and shut-down modes, in contrast to aviation, occur after 1500 ... 3000 hours. Nevertheless, starting parameters must be analyzed to detect deviations and determine necessity of adjustments in order to reduce time spent on starting procedure. During the start-up process, the total start-up time, the gas temperature overshoot behind the turbines, the acceleration rate, and the start-up of the limiting loops are monitored. Besides, it is possible to analyze the dynamics of temperature changes behind the turbines, measured by separate thermocouples, which can characterize the processes of ignition, flame overshoot, presence of defects of compressor units, etc. Monitoring of parameters in the process of shutdown can reveal such faults as fuel gas leaks, lack of generator unloading, etc.

During static operation and transitions between them, the parameters must be monitored for abnormalities. This control is more subtle than that implemented in the control system, since when setting the tolerances, the influence of weather conditions, mode of operation, the individual characteristics of each instance of GTE is taken into account.

The type of parameter estimation, called trendanalysis, is performed less frequently, for example on an hourly basis. In this case a sample of parameters is analyzed for a long period of time, for example 50 hours, in order to identify trends in changes of parameters. Simultaneously with trend analysis or even less frequently, fault prediction can be performed. To increase reliability, information for even longer period of GTE operation (up to 500 hours) can be included in the analyzed sample. In this case, the prediction time should not exceed the sample duration (50...100 hours).

2.4 Conclusions on the part

In the course of operation, the engine is influenced by operation factors, i.e. inrush, dumps, thermal unsteadiness of structural elements, wear of friction pairs, overloading during the aircraft evolution, change of climatic conditions, ingress of foreign objects, etc. The influence of exploitation factors is manifested in increase of radial clearances in blade machines, in wear of mating elements, seals, erosion change of the shape of blade profiles, appearance of backlashes in the HA drive, contamination of elements of flow part and channels of cooling system.

At the present time the processes, occurring in GTEs, are well enough studied. In general case they can be described by system of non-linear equations, linking state parameters (pressure loss coefficients, nodes efficiency coefficients, areas of flow-through sections, gas and air leakage values) and measured parameters (pressure and air and gas temperatures in different sections, rotor rotation frequency, fuel consumption, thrust).

Peculiarities of diagnostics of GTE's flow part are connected, first of all, with influence of parameters of the supercharger on parameters of GTE, possibilities of analysis of temperature field behind the turbine, measurement of gas parameters between turbines, use of measured electric power of electric generator as a mode parameter, application of periodic processing instead of processing of performed flight. The mentioned peculiarities affect the algorithms of diagnostics, though the main principles remain the same as for aviation GTEs.

PART 3.

Diagnostics of Gas Turbine Units and Compressors

3.1 Absolute pressure capacitive sensor DAE-12S

Designed to measure absolute pressure of air, fuel, oil in various systems of aircraft objects and output electrical signal proportional to the measured pressure, in the form of DC voltage. It can be used to measure the pressure of gaseous and liquid neutral media.



Figure 17 . General view of DAE-12S

Table 4

Measuring range, kgf/cm ²	from 0 to 12
Limit pressure, kgf/cm ²	18
Output signal: DC voltage, V,	from 0,5 to 4,5
Basic error in normal climate conditions , % of UPI	± 0,75
Total error in operating temperature range: – from –15 to +85 °C, % of UPI – from –15 to –60 °C, % of UPI – from +85 to +120 °C, %	± 0,75 ± 1,5 ± 2
Supply voltage, V	10
Mass, kg, not more than	0,3
Dimensions, mm: measuring unit - electronic block	Ø 30 x 54 Ø 30 x 68
Length of harness, mm	1 000 – 1 220
Ambient temperature, °C: - measuring unit - electronic unit	from –60 to +120 from –60 to +85
Vibration in the frequency range: - 5 to 85 Hz with acceleration, g - 85 to 175 Hz with acceleration, g - 175 to 2000 Hz with acceleration, g 5	5 10 30
Linear acceleration, g	10

Salt (sea) fog:	From 2 to 3
- water content, g/m ³	+ 35
- temperature, °C	20
- dispersity, μm 2 to 3	

DAE-12S sensor is made of two units: a converter and an electronic unit connected with a bundle. The sensor is manufactured using only domestic materials and components. Upon request, it is possible to introduce a version of the sensor with digital output signal according to the exchange protocol agreed with the customer. Sensor design is protected by a patent for invention.

Features

- High long-term stability of parameters.
- High reliability under conditions of vibration, shock and temperature.
- Uniform linear output characteristic.
- EMC tested.
- KD has the letter "O1".

3.2 Absolute pressure sensor capacitive DAE-D

It is designed to measure the absolute pressure of the air and outputting an electrical signal in the form of DC voltage, which varies in proportion to the measured pressure. The sensor is designed for diagnostics of aviation engines parameters. It can be used to measure the pressure of gaseous and liquid media.



Figure 18 .General view of DAE-D

Table 5

Accuracy in all operating conditions, % of UPI	±1
Power supply: supply voltage, V	6,8±0,7
Output signal DC voltage, V	from 0,5 to 4,5
Weight, kg	0,2
Dimensions, mm	Ø 30×94

Table 6

Sensor code	Measuring range pressure, kgs/cm ²	Overload pressure, kgs/cm ²
DAE-1,6Д	0...1,6	2,4
DAE-2,5Д	0...2,5	3,8
DAE-3Д	0...3,0	4,5
DAE-4Д	0...4,0	6,0
DAE-5Д	0...5,0	7,5
DAE-6Д	0...6,0	9,0
DAE-7Д	0...7,0	10,5
DAE-10Д	0...10,0	15,0
DAE-12Д	0...12,0	18,0
DAE-16Д	0...16,0	22,5
DAE-18Д	0...18,0	27,0
DAE-25Д	0...25,0	37,5
DAE-36Д	0...36,0	54,0
DAE-40Д	0...40,0	60,0

DAE-60Д	0...60,0	90,0
DAE-100Д	0...100	150,0
DAE-120Д	0...120	180,0
DAE-150Д	0...150	225,0
DAE-250Д	0...250	375,0

3.3 Thermodynamic calculation of gas turbine engines

Calculation data:

$$P_h := 101325 \quad T_h := 288.15$$

$$P_{in} := 0.98 \cdot P_h = 9.93 \times 10^4$$

$$T_{in} := T_h$$

$$\eta_{st} := 0.9$$

$$\pi_c := 9.6$$

$$k := 1.4$$

3.3.1 Determination of operating fluid parameters behind the compressor

The compressor efficiency is determined by the approximate formula:

$$\eta_k := \frac{\frac{k-1}{k} \pi_c^k - 1}{\frac{k-1}{k \cdot \eta_{st}} \pi_c^k - 1} = 0.865$$

Where η_k - stage efficiency, $\eta_{st} = 0.88-0.91$

Let's calculate the effective work of air compression in the compressor:

$$L_c := \frac{k}{k-1} \cdot r \cdot T_h \cdot \left(\pi_c^{\frac{k-1}{k}} - 1 \right) \cdot \frac{1}{\eta_k} = 3.043 \times 10^5$$

At

$$r := 287.3$$

And the air parameter behind the compressor:

$$P_c := P_{in} \cdot \pi_c = 9.533 \times 10^5$$

$$T_c := T_h + \frac{k-1}{k} \cdot \frac{L_c}{r} = 590.814$$

3.3.2 Determination of the working body parameter at the combustion chamber outlet

The gas pressure before the turbine is determined by the formula:

$$P_g := P_c \cdot \sigma_{kc} = 9.247 \times 10^5$$

At

$$\sigma_{kc} := 0.97$$

Where

σ_{kc} is the coefficient of total pressure recovery in the combustion chamber.

The average heat capacity in the combustion chamber is calculated by the formula:

$$P_g := P_c \cdot \sigma_{kc} = 9.247 \times 10^5$$

at

$$\sigma_{kc} := 0.97$$

Where

σ_{kc} is the coefficient of total pressure recovery in the combustion chamber.

The average heat capacity in the combustion chamber is calculated by the formula:

$$C_{pcp} := 878 + 0.208 \cdot (T_g + 0.48 \cdot T_c) = 1.179 \times 10^3$$

Relative fuel consumption:

$$g_t := \frac{C_{pcp} \cdot (T_g - T_c)}{\eta_r \cdot H_u} = 0.016$$

$$\text{At } \eta_r := 0.99; H_u := 43000000$$

The average coefficient of air excess in the combustion chamber is calculated by the formula:

$$\alpha := \frac{1}{g_t \cdot l_o} = 4.248$$

3.3.3 Determination of gas parameters behind the turbine

Let's calculate the effective work of all turbine stages of the TFE:

$$L_t := \frac{L_c}{(1 + g_t) \cdot (1 - g_c) \eta_m} = 3.12 \times 10^5$$

The gas pressure temperature before the turbine is determined by the formulas:

$$T_t := T_g - \frac{k_r - 1}{k_r} \cdot \frac{L_t}{r_r} = 894.402 ;$$

$$P_{tc} := P_g \cdot \left[1 - \frac{T_g - T_{tc}}{T_g \cdot \eta_{ta}} \right]^{\frac{k_r}{k_r - 1}} = 2.799 \times 10^5 ;$$

$$P_{gft} := 1.08 P_{in} = 1.072 \times 10^5$$

3.3.4 Turbodynamic calculation of turbojet engines with flow mixing

In calculation of turbojet engines with mixing of flows (Fig.) the degree of two-circuit is not set, but defined in the course of thermodynamic calculation. Before leading gas parameters behind the turbine, the calculation is performed according to the same equations as the calculation of turbofan engines with real nozzles.

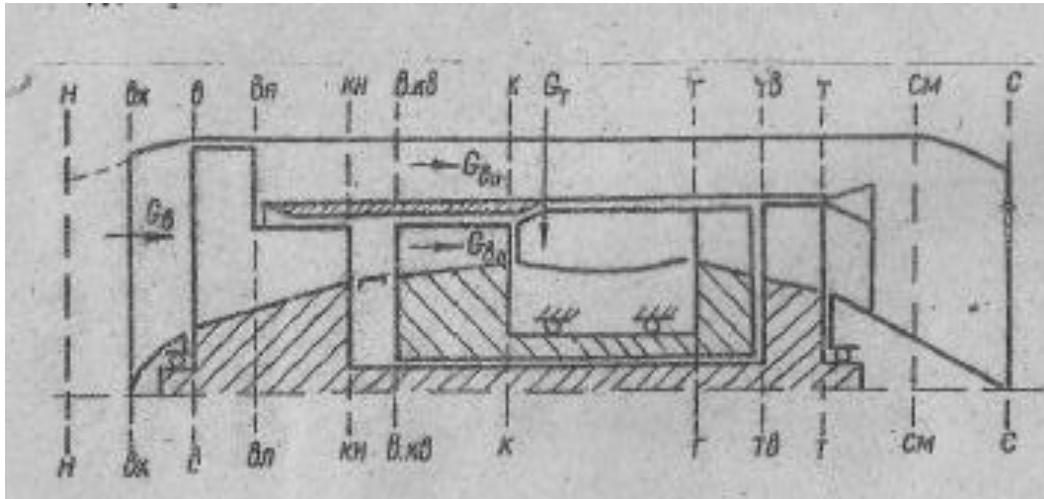

Figure 19. Determination of the degree of dual circuitry

In a two-circuit PDE with mixing flows, the gas pressure behind the turbine and the air pressure exiting the external circuit should be approximately the same.

From this condition, the gas expansion work in the turbine is determined:

$$L_{ft} := \frac{k_r}{k_r - 1} \cdot r_r \cdot T_{tc} \cdot \left[1 - \left(\frac{P_{gft}}{P_{tc}} \right)^{\frac{k_r - 1}{k_r}} \right] \cdot \eta_{ta \text{ explicit, ALL}} \rightarrow \frac{1.333}{1.333 - 1} \cdot 288 \cdot 894.4015430270407 \left[1 - \left(\frac{107242.38}{279911.74858995195} \right)^{\frac{1.333 - 1}{1.333}} \right] \cdot 0.9 = 1.978 \times 10^5$$

3.3.5 Determination of gas parameters behind the free turbine

The free turbine operation and the temperature behind it are determined by the formulas:

$$L_{ft} := \frac{k_r}{k_r - 1} \cdot r_r \cdot T_{tc} \cdot \left[1 - \left(\frac{P_{gft}}{P_{tc}} \right)^{\frac{k_r - 1}{k_r}} \right] \cdot \eta_{ta \text{ explicit, ALL}} \rightarrow \frac{1.333}{1.333 - 1} \cdot 288 \cdot 894.4015430270407 \left[1 - \left(\frac{107242.38}{279911.74858995195} \right)^{\frac{1.333 - 1}{1.333}} \right] \cdot 0.9 = 1.978 \times 10^5$$

$$T_p := T_{tc} - \frac{k_r - 1}{k_r} \cdot \frac{L_{ft}}{r_r} = 722.857$$

Setting the reduced turbine velocity at the free turbine outlet, find the gas velocity and static gas parameters behind the turbine by the formulas:

$$T_{tr} := T_p \cdot \left(1 - \frac{k_r - 1}{k_r + 1} \cdot \lambda_t^2 \right) = 679.265 \quad P_{tr} := P_{tc} \cdot \left(1 - \frac{k_r - 1}{k_r + 1} \cdot \lambda_t^2 \right) = 2.63 \times 10^5$$

$$C_t := \lambda_t \cdot \sqrt{2 \cdot \frac{k_r}{k_r + 1} \cdot r_r \cdot T_{tc}} = 352.654$$

If at P_r less than P_n , then behind the free turbine the flowing part of the inlet device has the form of a diffuser, in which the velocity decreases and the static pressure increases from P_t to $P_c = P_n$.

The velocity and temperature of the gas at the outlet of the outlet device are determined by the formulas:

$$C_s := \varphi_c \cdot \sqrt{2 \cdot \frac{k_r}{k_r - 1} \cdot r_r \cdot T_{tc} \cdot \left[1 - \left(\frac{P_h}{P_{tc}} \right)^{\frac{k_r - 1}{k_r}} \right]} = 664.99$$

$$T_{tg} := T_c - \frac{k_r - 1}{k_r} \cdot \frac{C_s^2}{2 \cdot r_r} = 399.026$$

At

$$\varphi_c := 0.978$$

3.3.6 Determination of basic specific parameters of turboshaft engines

Specific effective power (on the output shaft) and specific fuel consumption can be calculated by the formula:

$$N_{pf} := L_v \cdot (1 + g_t) = 2.009 \times 10^5$$

$$L_v := L_{fi} \quad C_e := \frac{3600 \cdot g_t \cdot (1 - g_c)}{N_{pf}} = 2.765 \times 10^{-4}$$

The airflow through the TVED is determined by the $\frac{L_v}{N_{pf}}$ ratio

$$G_a := \frac{N_e}{N_{pf}} = 7.322$$

The internal efficiency of the motor is calculated according to the formula:

$$\eta_e := \frac{L_v}{g_t \cdot H_u \cdot (1 - g_c)} = 0.298$$

Pressure by the compressor

17622	684647
18723	753106
19825	823909
20926	896998
22027	972322
23129	1049832
24230	1129483

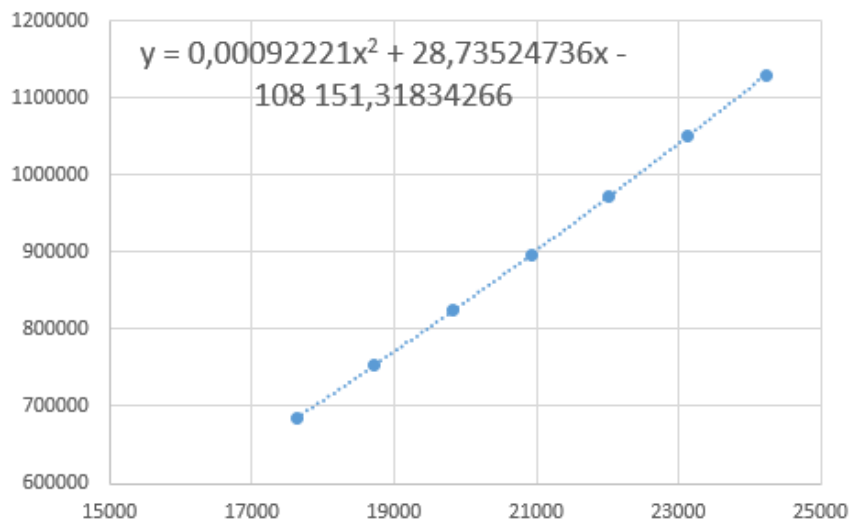

Temperature between the turbines:

17622	697,118
18723	741,976
19825	787,858
20926	836,33
22027	888,974
23129	947,45
24230	1014

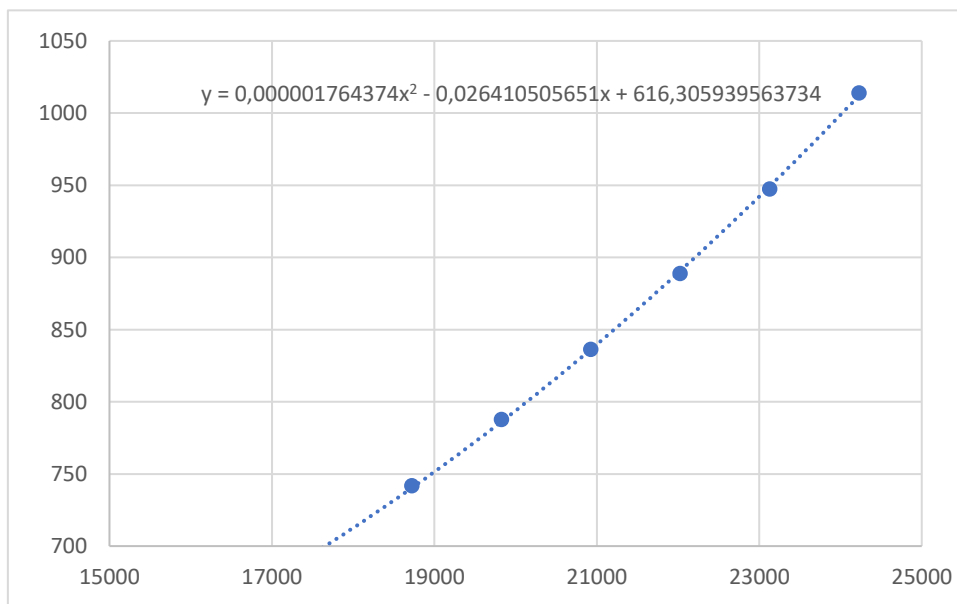

Fuel consumption

17622
18723

19825
20926
22027
23129
24230

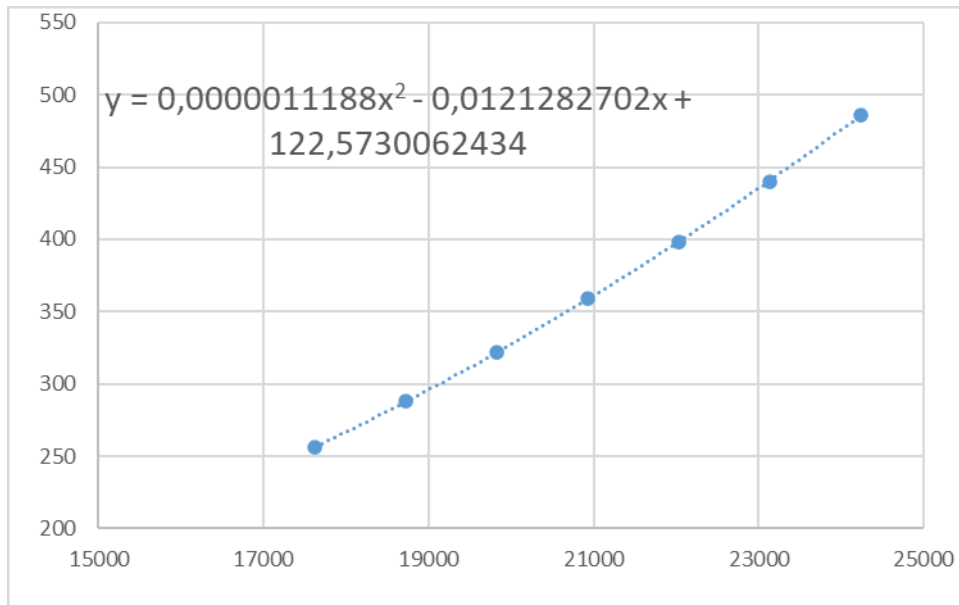

3.4 Diagnostics of the technical condition of the gas compressor unit according to thermal and gas-guzzling parameters

Standard diagnostic conditions and schedules of diagnostic deviations

$$n_{rpm} := n_{rpm} + rnorm\left(n, 0, \frac{0.1}{3 \cdot 100}\right)$$

$$T_{ind} := T_{ind} + rnorm\left(n, 0, \frac{1}{3}\right)$$

$$P_{ind} := P_{ind} + rnorm\left(n, 0, \frac{156906}{3 \cdot 100}\right)$$

$$G_{t1} := G_{t1} + rnorm\left(n, 0, \frac{650 \cdot 0.5}{100 \cdot 3}\right)$$

$$T_{rc} := T_{rc} + \text{rnorm}\left(n, 0, \frac{1}{3}\right)$$

$$P_{com} := P_{com} + \text{rnorm}\left(n, 0, \frac{1176798 \cdot 0.75}{3 \cdot 100}\right)$$

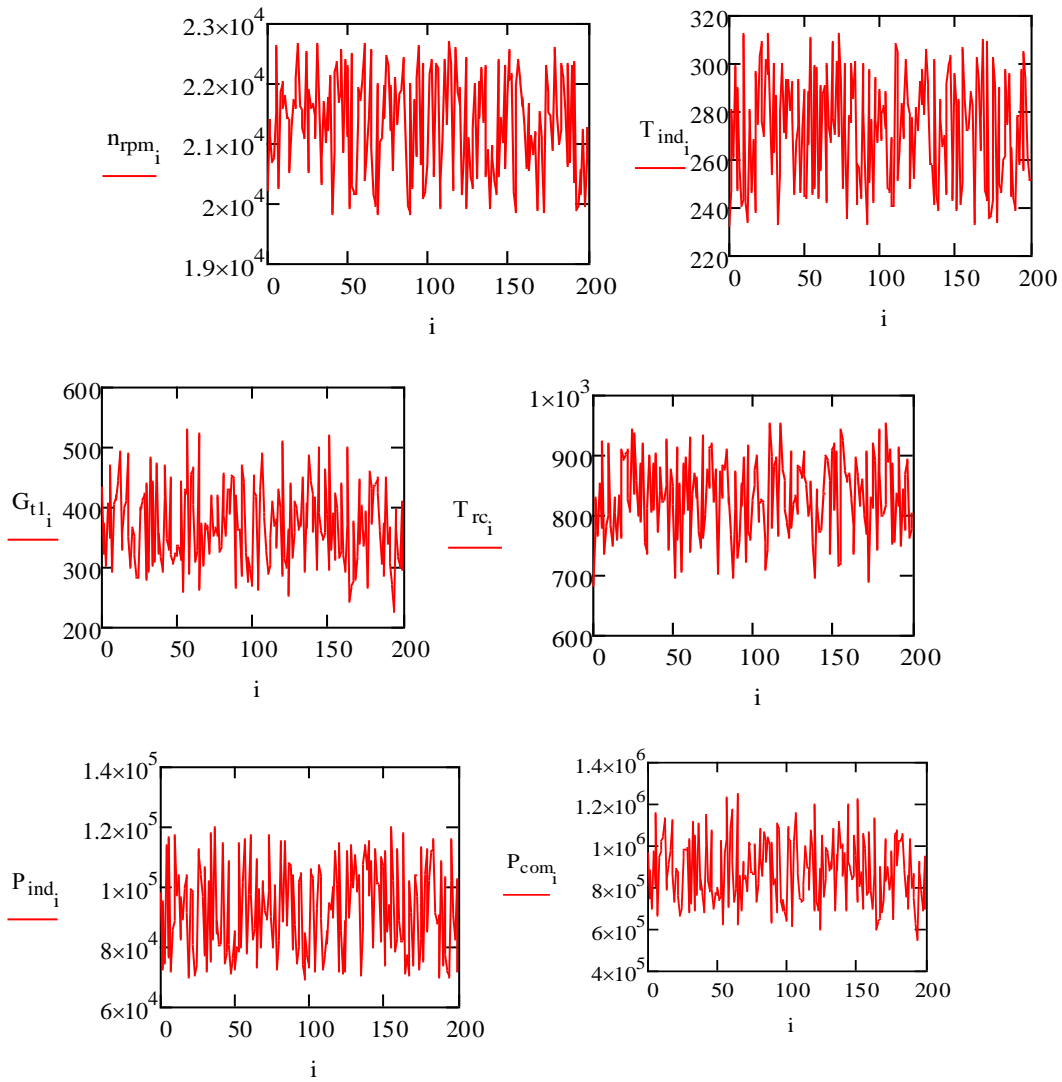

The cumulative value of the rotor speed:

$$n_{r_i} := n_{rpm_i} \cdot \sqrt{\frac{288}{T_{ind_i}}}$$

The cumulative value of the total temperature in the flowing part:

$$T_{3B}^* = T^* \frac{288}{T_H^*}$$

The cumulative value of the total pressure in the flowing part:

$$G_{r_i} := G_{t_i} \cdot \frac{101325}{P_{ind_i}} \cdot \sqrt{\frac{288}{T_{ind_i}}}$$

3.4.1 Calculation of normalized diagnostic deviations

The purpose of calculation is to obtain the values of TC features, which do not depend on the engine operation mode. The formation of TC features is performed by comparing the reference values of the parameter in the current mode and the values obtained during operation.

To calculate the reference values of the parameter, the following dependencies were used:

- dependence of the compressor braking pressure reduced to the ACS on the summary rotor frequency of an average engine:

- dependence of the compressor braking temperature reduced to the ACS on the summary rotor frequency of the reference motor

$$P_{s_i} := 0.00092221 \cdot (n_{r_i})^2 + 28.73524736 \cdot n_{r_i} - 108151.1$$

$$T_{s_i} := 0.0000017643 \cdot (n_{r_i})^2 - 0.02641 \cdot n_{r_i} + 616.1$$

$$G_{s_i} := 0.0000011188 \cdot (n_{r_i})^2 - 0.012128 \cdot n_{r_i} + 122.57$$

After calculating the values of the summary parameters of the diagnosed and the reference engine, the value of the diagnostic deviation should be calculated:

$$\Delta G_i := G_{r_i} - G_{s_i}$$

$$\Delta P_i := P_{r_i} - P_{s_i}$$

$$\Delta T_i := T_{r_i} - T_{s_i}$$

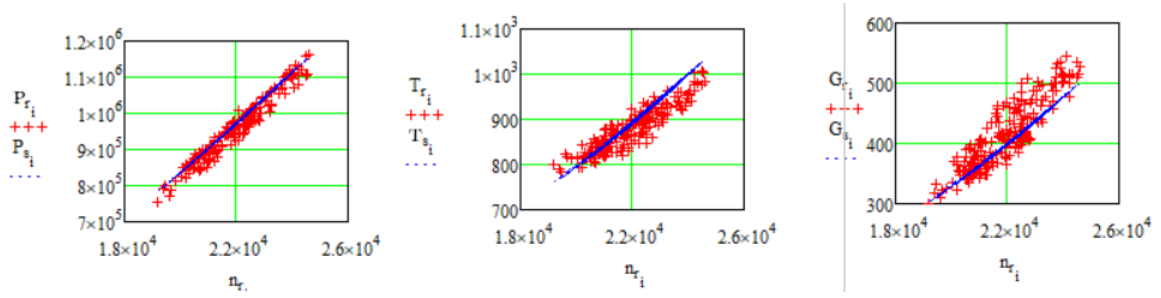

At the end of the calculation of the TC attributes compared the obtained values with the scatter associated with measurement errors and inadequacy of the reference models. To perform normalization of the diagnostic deviations obtained from the dependence:

$$\Delta_{P_{n_i}} := \frac{\Delta_{P_i}}{\Delta_{P_{norm}}}$$

$$\Delta_{T_{n_i}} := \frac{\Delta_{T_i}}{\Delta_{T_{norm}}}$$

$$\Delta_{G_{n_i}} := \frac{\Delta_{G_i}}{\Delta_{G_{norm}}}$$

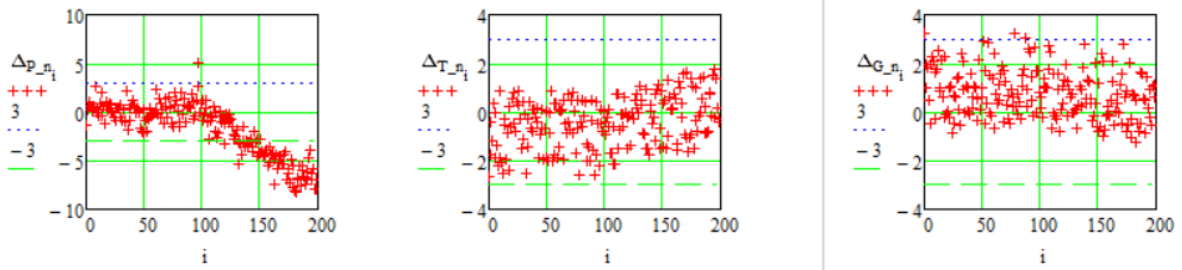

The parameter value is calculated as the standard deviation of the first $N = 10 + Rnd(V/3)$ points (the $Rnd()$ function means an integer part of the number

$$M\Delta_P := \frac{\sum_{i=0}^{K-1} \Delta_{P_i}}{K} = 659.987$$

$$M\Delta_T := \frac{\sum_{i=0}^{K-1} \Delta_{T_i}}{K} = -17.132$$

$$M\Delta_G := \frac{\sum_{i=0}^{K-1} \Delta_{G_i}}{K} = 23.015$$

$$\Delta_{P_norm} := \sqrt{\frac{\sum_{i=0}^{K-1} (\Delta_{P_i} - M\Delta_P)^2}{K-1}} = 6.246 \times 10^3$$

$$\Delta_{T_norm} := \sqrt{\frac{\sum_{i=0}^{K-1} (\Delta_{T_i} - M\Delta_T)^2}{K-1}} = 25.523$$

$$\Delta_{G_norm} := \sqrt{\frac{\sum_{i=0}^{K-1} (\Delta_{G_i} - M\Delta_G)^2}{K-1}} = 25.522$$

3.4.2 Minimizing the influence of the random factor

To minimize the effect of random factor it is necessary to smooth the values of pressure, time, power as time series

At the exponential smoothing it is needed to use the dependence, at

Pressure

$$\alpha = 0,8$$

$$\Delta_{P_s8_0} := \Delta_{P_n_0}$$

$$\Delta_{P_s8_j} := \Delta_{P_s8_{j-1}} + \alpha \cdot (\Delta_{P_n_j} - \Delta_{P_s8_{j-1}})$$

$$\alpha = 0,6$$

$$\Delta_{P_s6_0} := \Delta_{P_n_0}$$

$$\Delta_{P_s6_j} := \Delta_{P_s6_{j-1}} + \alpha \cdot (\Delta_{P_n_j} - \Delta_{P_s6_{j-1}})$$

$$\alpha = 0,4$$

$$\Delta_{P_s4_0} := \Delta_{P_n_0}$$

$$\Delta_{P_s4_j} := \Delta_{P_s4_{j-1}} + \alpha \cdot (\Delta_{P_n_j} - \Delta_{P_s4_{j-1}})$$

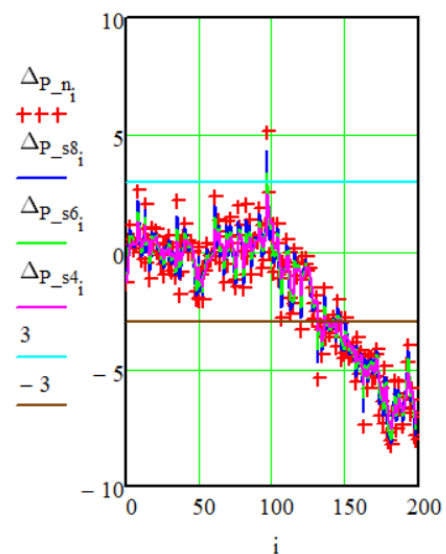

$$\alpha = 0,4$$

Temperature

$$\alpha = 0,8$$

$$\Delta_{T_{s8}_0} := \Delta_{T_{n_0}}$$

$$\Delta_{T_{s8}_j} := \Delta_{T_{s8}_{j-1}} + \alpha \cdot (\Delta_{T_{n_j}} - \Delta_{T_{s8}_{j-1}})$$

$$\alpha = 0,6$$

$$\Delta_{T_{s6}_0} := \Delta_{T_{n_0}}$$

$$\Delta_{T_{s6}_j} := \Delta_{T_{s6}_{j-1}} + \alpha \cdot (\Delta_{T_{n_j}} - \Delta_{T_{s6}_{j-1}})$$

$$\alpha = 0,4$$

$$\Delta_{T_{s4}_0} := \Delta_{T_{n_0}}$$

$$\Delta_{T_{s4}_j} := \Delta_{T_{s4}_{j-1}} + \alpha \cdot (\Delta_{T_{n_j}} - \Delta_{T_{s4}_{j-1}})$$

Power

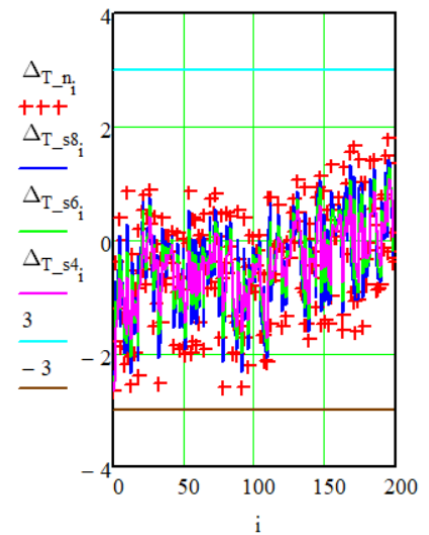

$$\alpha = 0,8$$

$$\Delta_{G_{s8}_0} := \Delta_{G_{n_0}}$$

$$\Delta_{G_{s8}_j} := \Delta_{G_{s8}_{j-1}} + \alpha \cdot (\Delta_{G_{n_j}} - \Delta_{G_{s8}_{j-1}})$$

$$\alpha = 0,6$$

$$\Delta_{G_{s6}_0} := \Delta_{G_{n_0}}$$

$$\Delta_{G_{s6}_j} := \Delta_{G_{s6}_{j-1}} + \alpha \cdot (\Delta_{G_{n_j}} - \Delta_{G_{s6}_{j-1}})$$

$$\alpha = 0,4$$

$$\Delta_{G_{s4}_0} := \Delta_{G_{n_0}}$$

$$\Delta_{G_{s4}_j} := \Delta_{G_{s4}_{j-1}} + \alpha \cdot (\Delta_{G_{n_j}} - \Delta_{G_{s4}_{j-1}})$$

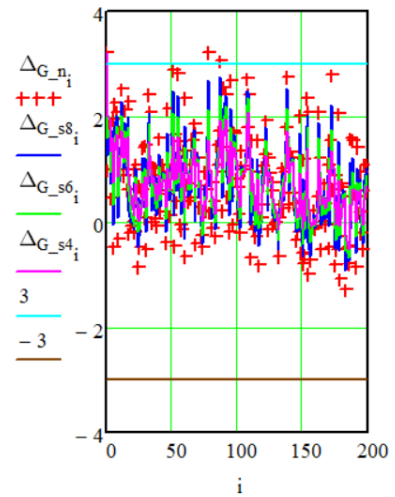

When using sliding tape smoothing, smoothing is performed by three points. The smoothed value of all points except the first and the last

$$M = 3$$

$$j3 := M - 1..n - 1$$

$$\Delta_{G_{s3}_{j3}} := \frac{\sum_{i=j3-M+1}^{j3} \Delta_{G_{n_i}}}{M}$$

$$M = 5$$

$$j5 := M - 1..n - 1$$

$$\Delta_{G_{s5}_{j5}} := \frac{\sum_{i=j5-M+1}^{j5} \Delta_{G_{n_i}}}{M}$$

$$M = 7$$

$$j7 := M - 1..n - 1$$

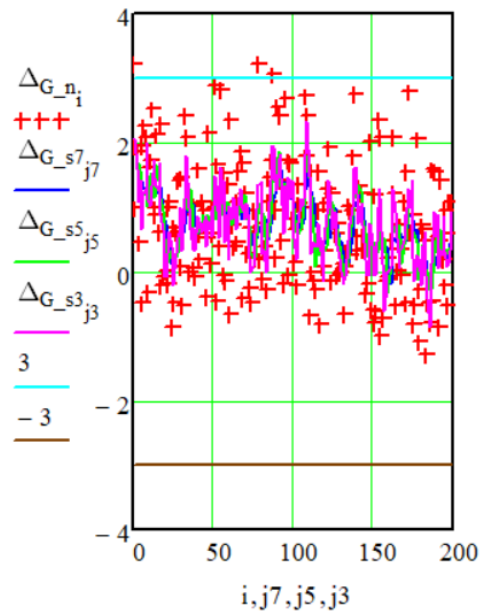

$$\Delta_{G_s7,j7} := \frac{\sum_{i=j7-M+1}^{j7} \Delta_{G_n,i}}{M}$$

$$M = 3$$

$$j3 := M - 1..n - 1$$

$$\Delta_{P_s3,j3} := \frac{\sum_{i=j3-M+1}^{j3} \Delta_{P_n,i}}{M}$$

$$M = 5$$

$$j5 := M - 1..n - 1$$

$$\Delta_{P_s5,j5} := \frac{\sum_{i=j5-M+1}^{j5} \Delta_{P_n,i}}{M}$$

$$M=7$$

$$j7 := M - 1..n - 1$$

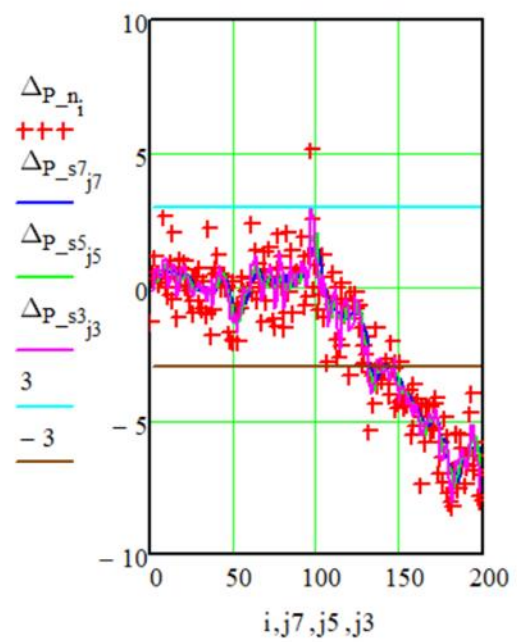

$$\Delta_{P_{s7,j7}} := \frac{\sum_{i=j7-M+1}^{j7} \Delta_{P_{n_i}}}{M}$$

M=3

$$j3 := M - 1..n - 1$$

$$\Delta_{T_{s3,j3}} := \frac{\sum_{i=j3-M+1}^{j3} \Delta_{T_{n_i}}}{M}$$

M=5

$$j5 := M - 1..n - 1$$

$$\Delta_{T_{s5,j5}} := \frac{\sum_{i=j5-M+1}^{j5} \Delta_{T_{n_i}}}{M}$$

M=7

$$j7 := M - 1..n - 1$$

$$\Delta_{T_{s7,j7}} := \frac{\sum_{i=j7-M+1}^{j7} \Delta_{T_{n_i}}}{M}$$

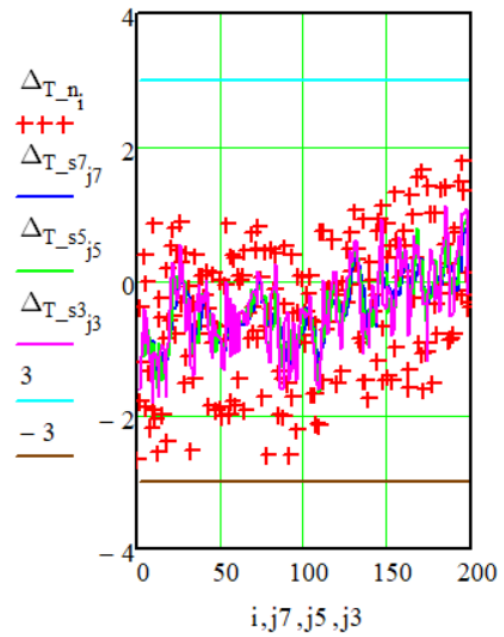

3.5 Conclusions on the part

In this section, we performed diagnostics of the technical condition of the gas compressor unit by thermo-gas-dynamic parameters. we plotted the dependence of temperature, pressure, power, depending on diagnostic deviations and sliding parameters.

Chapter 4. Environmental Protection

Influence of air transport on the environment

4.1. Impact of ground sources of air transport on the environment.

Aviation, compared to other types of transport, is a specific polluter with a fairly wide range of impact on the quality of the environment.

The negative impact of air transport on the environment is both global and local in nature.

The global influence consists in the formation of the greenhouse effect and destruction of the ozone layer.

Terrestrial sources of pollution are conventionally divided into those that located inside the airport, and those located outside its borders. The latter include, first of all, thermal power plants that operate on various types of local fuel, therefore the nature of pollution is determined by the types of fuel, methods of burning it, and ways of removing emissions.

The intraport sources of NPS pollution include:

- ventilation systems, which are used in separate sections of aircraft maintenance;
- aviation fuel supply enterprises;
- special vehicle transport.

If necessary, when the air removed from the workers places, contains harmful substances in large quantities, before being released into the atmosphere, it is cleaned in dust collection and gas cleaning facilities.

In atmospheric air from industrial premises and individual airport facilities are provided:

- vapors of oil products, solvents, paint materials, alkalis, acids;

- aerosols of aqueous solutions of caustic, carbonic and phosphoric acid sodium, sulfuric anhydride, nitrogen oxides, carbon monoxide, dust.

The amount of harmful substances entering the atmosphere air from the industrial premises of the airport or aircraft repair shop for water through the ventilation systems may exceed the maximum permissible values, which cause the exceeding of the maximum empty concentrations of these harmful substances.

Most often, this happens with the group arrangement of ventilation shafts, when the effect of summation of harmful emissions occurs, and even form new harmful substances of higher toxicity.

4.2. The influence of air sources of air transport on the environment.

Aircraft pollute the atmosphere due to emissions of harmful substances with exhaust gases of aircraft engines.

Airplanes during the flight move from one airport to another, polluting the atmosphere on a global scale, i.e. significant pollution occurs both in airport areas and on highways flight. Moreover, if on the flight paths (at an altitude of 8–12 km) the safety from this pollution is insignificant (aircraft flights at a high at a height and at a high speed cause the dispersion of products combustion in the upper layers of the atmosphere and in large areas, which reduces the level of their impact on living organisms), then in the airport area such pollution cannot be neglected.

Gases are released into the atmosphere by nozzles and exhaust pipes of engines. This process is called the emission of aircraft engines.

Gases formed as a result of the operation of aircraft engines make up 87% of all civil aviation emissions, including also with emissions from special vehicles and stationary sources.

The most unfavorable operating modes are low speeds and engine idling, when pollutants are released into the atmosphere in quantities that significantly exceed emissions on loading modes.

The chemical composition of emissions resulting from fuel combustion largely depends on the type and quality of fuel, production technology, the method of combustion in the engine and the technical condition of the engine.

The main components of modern aviation exhaust gases

engines that pollute the atmosphere:

- sulfur oxides SO_x ;
- nitrogen oxides NO_x ;
- carbon dioxide CO_2 ;
- unburned hydrocarbons, C_xH_y (methane CH_4 , acetylene C_2H_2 , ethane C_2H_6 , benzene C_6H_6 , etc.);
- aldehydes (formaldehyde HCHO , acrolein $\text{CH}_2=\text{CH}=\text{CHO}$, acetic aldehyde CH_3CHO , etc.);
- soot (finely dispersed particles of pure carbon), which is released in the form of a plume behind the nozzles of the engines during take-off aircraft (soot is released in general not much).

The content of NO_x in the exhaust gases of an aircraft engine depends on:

- temperature of the mixture in the combustion chamber (the higher it is, the more NO_x is formed), and it is maximum (2500–3000 K) at take-off mode;
- the time the mixture stays in the combustion chamber (the longer it is, the then more NO_x is formed), and this happens at low speeds of the aircraft.

That is, the maximum emission of NO_x occurs on take-off engine mode and modes close to it (during take-off aircraft and during its gain of flight height).

4.3. Emissions of harmful substances during the operation of aviation refueling enterprises.

The main function of aviation refueling enterprises is to ensure the timely refueling of aircraft by keeping the necessary fuel reserve, preparing for issuance and boarding the aircraft.

Today, 75% of oil product losses in reservoirs are these enterprises (Fig. 1.3) accounts for losses from evaporation, which leads not only to the deterioration of product quality, but also to significant pollution of the environment with toxic substances.

From the point of view of ensuring environmental safety, the largest mass of atmospheric pollution is the fuel storage process. It related to the physical and chemical properties of fuels, their conditions storage and features of construction and operation of technological equipment.

The main factor of fuel evaporation is the high pressure of saturated vapors of petroleum products and, as a result, the transfer of volatile fractions into the gas phase. Evaporation increases with elevation the temperature of the surface of petroleum products or a decrease in the pressure in the gas space of the tanks.

During the storage of oil products in tanks, usually fuel losses occur as a result of the following processes: small "breathing" of tanks, large "breathing" of tanks, reverse "views" of tanks, ventilation of the gas space of tanks containers, etc. Percentage shares in total losses caused by these processes shown in fig. 1.4.

Losses from small "breaths" occur due to cyclical ones temperature and partial pressure fluctuations in the gas space reservoir, caused by the daily action of solar radiation and atmospheric conditions on the walls and roof of the tanks. Duration of one cycle is usually equal to a day.



Fig. 20. Appearance of tanks at the fuel storage warehouse

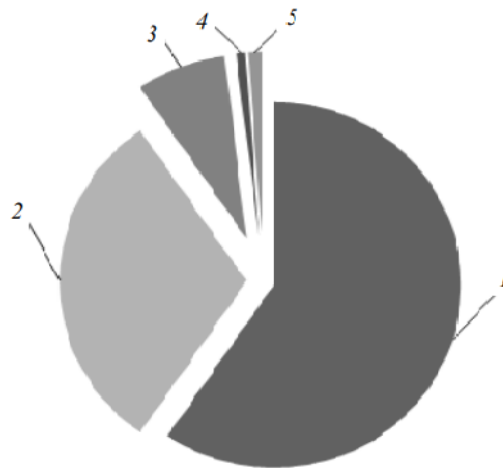

Fig. 21. The structure of natural loss of oil products:
 1 — due to ventilation gas space of the tank (62%); 2 — at the expense of the big one "breathing" of the tank (32%);
 3 - due to small "breathing" reservoir (8%); 4 — for the account

reverse "exhalation"

reservoir (0.8%); 5 - other types

losses (1.2%)

Losses from large "breaths" depend mainly on volumes and the temperature of the fuel pumped into the tank, as well as concentration of petroleum product vapors in a vapor-air mixture, their density and pressure.

Losses from ventilation of the gas space — losses resulting from incorrect installation of breathing valves, insufficient tightness of the roof of the tanks. The magnitude of such losses can sometimes exceed losses from small and large "breaths". Ventilation losses are considered as a result of blowing by the wind of vapors of oil products due to the leaky roof tanks, as well as as a result of the occurrence of a gas siphon in the space above the fire.

There is also the concept of loss from reverse "exhalation". Its essence in the fact that after partial or complete emptying of the tank, the gas space remains unsaturated with oil product vapors. Under time of still storage of the remaining oil product, the gas space is saturated due to evaporation the remainder The process is accompanied by an increase in the partial pressure of vapors in the gas space, the total pressure increases. In case of achievement of the total pressure level, which is equal to the calculated pressure, the breathing valve is activated, a certain volume of gas-air mixture is released into the atmosphere, i.e. reverse "exhalation".

Depending on the time of year and the type of oil products, their evaporation and, therefore, emissions from small "breaths" differ significantly.

The largest mass of emissions of harmful substances falls on heat time of year So, for example, in just one summer month, from turning a sludge steel tank with a volume of 1000 m³, RVS-1000 can evaporate into the atmosphere up to 217 kg of aviation jet of TS-1 fuel, and with RVS-5000 — already 618 kg (Fig. 2.5). They are more significant losses of gasoline: from the reservoir RVS-1000 can evaporate in atmosphere for a month up to 2281 kg, and RVS-5000 — 7815 kg of fuel.

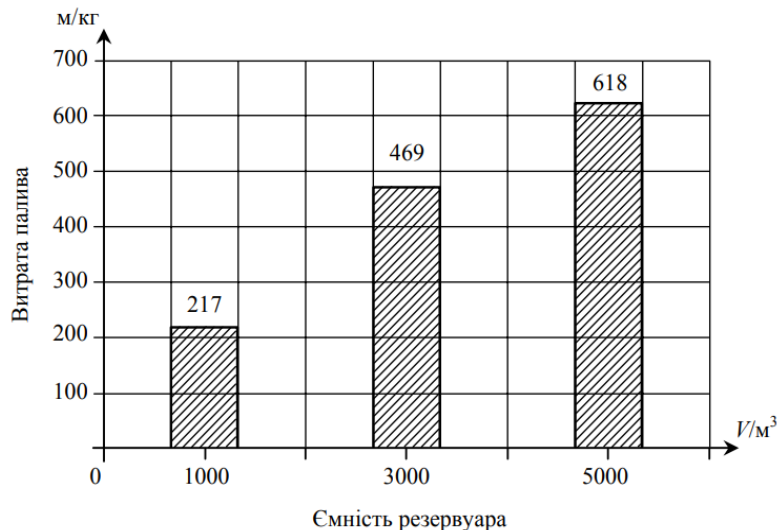

Fig. 22. Dependence of monthly losses of TS-1 aviation fuel from the tank capacity (summer month)

In tanks with different fuel filling heights, losses from of small "breaths" decrease as the pouring height increases. In case of storage of oil product in a tank filled with 20–50%, vapor emissions are much higher than in a tank with a maximum pouring height (Fig. 1.6).

This is explained by the fact that in tanks filled to 20%, the gas-air mixture is 80% of the total volume, i.e. more oil product evaporates.

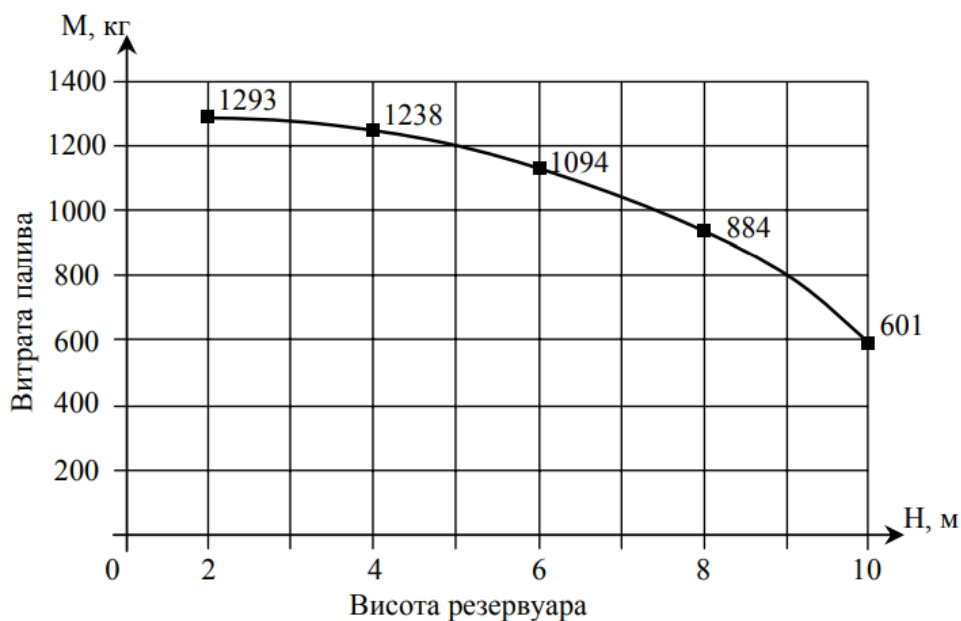

Fig. 23. Dependence of TS-1 aviation fuel losses on altitude

pouring in the RVS-3000 tank in 30 days in small "breaths"

4.4. Ways to reduce environmental hazards from emissions of oil vapors.

Aviation fuel losses due to evaporation are the most significant in the reservoir park of fuel supply enterprises. The main ways of reducing them:

- reduction of the volume of the gas space of the tanks due to the use of timely pumping of fuels from other tanks in the coldest time of day (mornings);
- use of double-wall construction tanks and with a double bottom (like a "glass in a glass") (Fig. 1.7);
- capture and regeneration of vapors of oil products coming out of the tank by creating gas comparison systems, absorption-adsorption and ejection installations;
- implementation of organizational measures consisting in systematic inspection and maintenance of the technical condition of reservoirs and their "breathing" equipment;
- reflective painting of the reservoir park.

In order to reduce emissions of oil product vapors into the environment it is expedient and economically justifiable to install under the installation through the nozzle of the "breathing" valve of the tank, reflector discs (Fig. 1.8).

The principle of their operation consists in changing the direction of the jet along the wind entering the tank from vertical to horizontal.

Then gas-air layers significantly saturated with petroleum product vapors, located in the fuel surface, will practically not be affected convective flows.

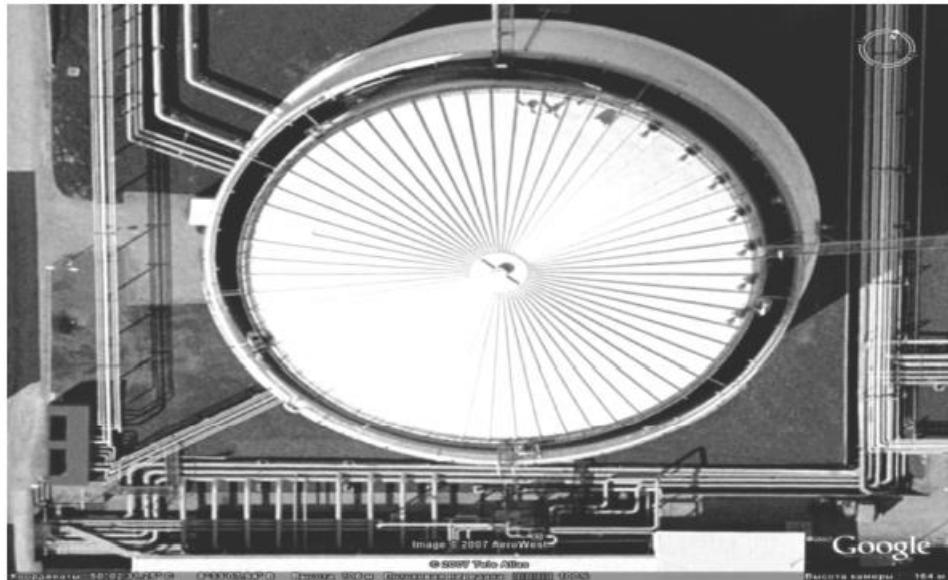

Fig. 24. Top view of a double wall tank and double bottom.

The use of reflective discs is highly effective in gasoline and fuel tanks with a high turnover ratio. Yes, thanks to them establishing a loss from large "breathing" during the warm season are reduced by 30–40%. In the cold this time of year is constructive the solution is ineffective because it is cold the air entering the tank is heavier than the gas-air mixture and goes straight to surface of the product, stirring at this saturated layers tank body and roof. Painting the outer surface tanks in light tones are most widely used in practice operation of tanks with light petroleum products. What paints used for this purpose, must have a reflection coefficient greater than 0.8 (Table 2.3). However, the reflectivity of the paint gradually decreases due to surface contamination, as well as chemical contamination changes and mechanical damage to the paint coating, therefore it needs to be periodically restored.

Since losses from the evaporation of volatile oil products largely depend on the amplitude fluctuations in the temperature of the steam-air mixture in the tank, to reduce the latter, external reflective painting is used.

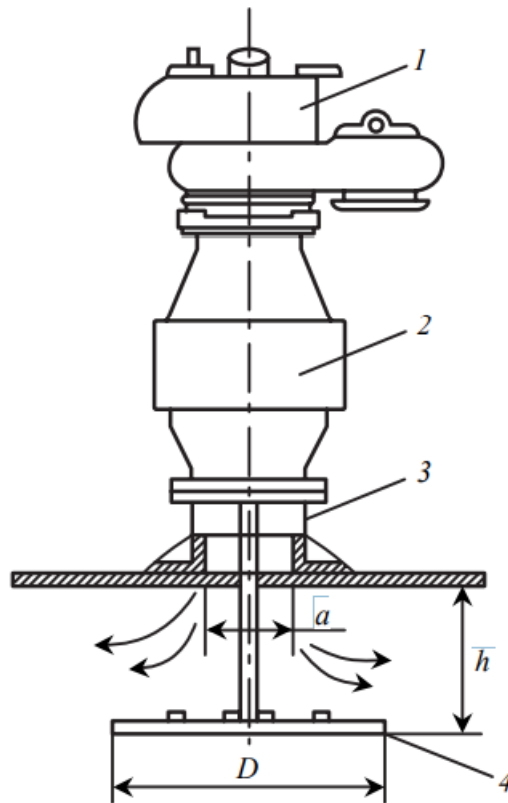

Fig. 25. Disc-reflector: 1 — "breathing" valve; 2 — bolt; 3 — intermediate flange; 4 — disc.

4.5. Leakage of oil products on fuel supply enterprises and methods of their reduction.

Improper operation of facilities of fuel supply companies, violation of equipment and equipment operating conditions, operation of outdated equipment, lack of systems, automatic health, check equipment and possible leaks, oil product — all these are the main ones man-made factors accidents and situations dangerous for the environment.

Operational measures include:

- timely performance of technical maintenance of equipment and equipment, testing of tanks for tightness and strength;
- implementation of flaw detection and inspection of fuel storage tanks in order to identify possible design defects;

– sealing and strengthening of the inner bottom of the tank with a layer of special coating based on epoxy compositions.

Organizational activities include:

– organization of continuous concrete embankment of the fuel storage area (Fig. 1.16);

– organization of planned technical maintenance of technological equipment;

– timely conducting of training and improvement of technical staff qualifications.



Fig. 26. Organization of solid concrete collapse of the fuel storage area

Conclusions

In part 4, I described how airplanes affect the environment and what consequences this can lead to.

What is more, I paid attention to how land-based sources of air transport affect the environment and why the amount of harmful substances entering the atmosphere air from the industrial premises of the airport or aircraft repair plant through the ventilation systems may exceed the maximum permissible values, which cause the maximum permissible concentrations of these harmful substances to be exceeded.

Also, I indicated how it is possible to reduce vapors of petroleum products.

Moreover, I gave an example of how to reduce the leakage of petroleum products at fuel supply enterprises.

Part 5

Labour Protection

5.1. Power plant maintenance

During the maintenance of power plants, the following main hazardous and harmful production factors may occur:

- moving elements of the aircraft power plant (air and main rotors, engine rotors, transmission shafts, engine cowl doors, reversing devices);
- increased temperature of aircraft engine surfaces;
- increased slip due to icing, moistening and oiling of aircraft surfaces, ladders, stepladders, ladders and coverings of parking areas along which personnel move;
- jets of exhaust gases flowing out at high speeds when starting and testing aircraft engines, and objects, stones, sand falling into these jets;
- outgoing streams of gases and liquids from vessels, chassis units and pipelines operating under pressure;
- air suction flows moving at high speed in the area of air intakes of aircraft engines;
- increased noise level during operating aircraft power plants.

It is allowed to start maintenance of aircraft power plants after the complete stop of rotation of the propellers and engine rotors, installation of thrust blocks under the wheels of the landing gear, connection of the aircraft to the grounding device and cooling of the hot parts of the engine and its systems.

Before performing work on the engine, make sure that the hood covers are securely fixed to prevent their spontaneous movement and injury to aviation personnel.

When manually turning the propeller blades, the workers must be outside the plane of its rotation.

Before manually turning the main rotor blades of the helicopter, it is necessary to make sure that there are no people and equipment in the area of rotation of the main and tail rotors.

During work on the control of the compressor and turbine blades associated with the rotation of the engine rotor, the actions of the personnel must be coordinated. During repair work, the motor rotor must be securely locked with locks provided for by the maintenance technology for this type of motor.

When working in the channel of the engine flow part, the worker must be equipped with a safety rope for evacuation from the channel if necessary.

When installing and dismantling the units of the fuel, oil and hydraulic systems of the engine, pallets must be installed under it.

Flushing of the engine should be carried out with a washing liquid, provided by the technology, after it has completely cooled down and with the adoption of measures to limit the ingress of washing liquid on aviation personnel, rubber products, electrical wiring, special equipment units and the aircraft parking area.

When removing oil, fuel, dirt from the parts of the power plant, it is necessary to use only the washing and cleaning materials specified in the maintenance procedure.

Flushing of fuel and oil filters of power plant units should be carried out only in a specially designated place with subsequent disposal of contaminated flushing fluid.

Ultrasonic cleaning of filters of fuel and oil systems of the power plant must be carried out in compliance with safety requirements in accordance with GOST 12.1.001-89 (section 2, clause 31 of these Rules).

Works on instrumental ultrasonic testing of propeller blades must be carried out with grounded aircraft, a flaw detector and a stepladder, from which testing is carried out. Before switching on the flaw detector, it is necessary to make sure that the insulation of the power supply cables is reliable.

Installation (dismantling) of power plants should be carried out in hangars, docks or specially equipped sites under the guidance of a foreman.

Mounting (dismantling) of aircraft engines, auxiliary power units, other items of aviation equipment weighing more than 20 kg should be carried out using mechanization.

The engine should be started no earlier than 30 minutes after its depreservation and flushing in the presence of standard fire extinguishing equipment. The first start of the engine, after its installation, is allowed to be carried out in the presence of a fire truck with a team.

Starting and testing of engines should be carried out after the termination of other work on the aircraft. At the same time, only aviation personnel directly involved in the preparation and conduct of the launch are allowed to be near the aircraft. When the engines are running, it is forbidden to be in the plane of rotation of the propellers.

When starting and testing the engine, connecting the power supply to the aircraft is allowed only at the command of the person making the start.

Persons supervising the start of engines from the ground must be equipped with means of communication with the cockpit and personal protective equipment for hearing organs, ensuring that the sound level is reduced to a level not exceeding 80 dBA.

Before testing the engine or its reversing devices in the summer, it is necessary to water the launch site in order to prevent increased dust formation.

It is forbidden to carry out adjustment work on a running engine. Checking the tightness of units, pipelines, fuel, oil and hydraulic systems located on the

engine is carried out with the engine running, taking precautions to prevent aviation personnel from getting into the zone of the suction or outgoing jet, as well as into the zone of rotation of the air (main and tail) propellers .

When the engine is running, people, equipment and structures should not be in the zone of gas jet outflow. Dangerous distances are less than 50 m in the direction of the gas outlet from the engine and less than 10 m in front of the engine air intake.

Purging filters and other parts of the power plant with compressed air should be carried out in accordance with the technological guidelines for each type of engine, not exceeding the set pressure and directing the air stream away from the workers.

Inspection of the nozzle and turbine of engines with reversing devices must be carried out with completely relieved pressure in the thrust reverser control system.

5.2. Aircraft refueling with fuels and lubricants and special liquids

When refueling aircraft with fuels and lubricants and special liquids (hereinafter referred to as refueling), the following main hazardous and harmful production factors may occur:

- increased slip due to icing, moistening and oiling of aircraft surfaces, ladders, stepladders, ladders and coverings of parking areas along which personnel move;
- aircraft, special vehicles, self-propelled machines and mechanisms that move;
- placement of a workplace or working area at a distance of less than 2 m from unenclosed differences in height of 1.3 m or more;
- increased noise level;

- an increased level of static electricity on the surfaces of filling facilities and aircraft when pumping and draining fuel through pipes and dispensing hoses, when refueling with a falling jet and spraying it, when mixing and foaming the fuel;
- fire (explosion) of the aircraft and refueling facilities due to the presence of a combustible and explosive environment.

The movement and location of self-propelled and transportable wheeled refueling facilities, as well as the movement of aircraft when taxiing to places of fuel and lubricants refueling at aerodromes and sites must be carried out in accordance with the requirements of the Guidelines for the organization of the movement of aircraft, special vehicles and mechanical equipment at civil aviation aerodromes (section 2, paragraph 50 of these Rules).

Aircraft refueling should be started only after:

- complete stop of the aircraft at the parking lot;
- complete stop of rotating propellers and turbine rotors;
- installation of persistent pads under the wheels of the chassis;
- mooring of the aircraft main and tail rotor blades (if it is required to be performed according to the weather conditions of the aerodrome for this type of aircraft);
- disembarkation of passengers;
- grounding of the aircraft and the means of filling, as well as the connection of the aircraft and the means of filling with a conductor for equalizing potentials;
- natural or artificial cooling of the hot parts of the aircraft to the temperature established by the maintenance technology;
- removal of spilled fuels and lubricants from the surfaces of aircraft parking areas, aircraft surfaces and used equipment;

- checking the availability of fire extinguishing equipment at aircraft parking areas;

- as well as in the absence of the smell of fuel and lubricants in the cabins, baggage, service and technical compartments of the aircraft.

During aircraft refueling (fuel draining) it is prohibited:

- perform any kind of maintenance and repair of aircraft and refueling facilities, as well as loading and unloading operations;

- use an open flame, faulty portable lamps, to control work regarding refueling (draining);

- connect (and disconnect) the airfield power supply to the aircraft on-board network;

- turn on or off the sources and consumers of electrical power, except for the switches for electrical signaling of aircraft fuel tanks;

- place the engine of the refueling facility (TZ, unit) under the wing of the refueling aircraft;

- pass or stop under the wing of the aircraft by any type of transport;

- start refueling if there is no free way of withdrawal (removal) of the refueling agent from the aircraft and in the presence of severe overheating of the wheel braking devices.

It is prohibited to refuel the aircraft openly during rain and strong wind with dust, during a thunderstorm (during discharges of atmospheric electricity) and closed refueling during lightning discharges.

Aircraft refueling (draining) must be carried out strictly according to the technology of the Standard Flow Chart.

Unwinding from the drums of distributing sleeves with tips and cables - conductors for equalizing the potentials of static electricity should be carried out

after checking the reliability of fastening the tips and removing the rotating drums from the latches when manually driven, in the direction perpendicular to the axis of rotation of the drum and using protective gloves.

During the top refueling of the aircraft, it is necessary to insure the rise of the tanker along the stepladder (ladder) to the plane of the aircraft and give him a dispensing valve (pistol). Upon completion of aircraft refueling, it is necessary to accept a dispensing crane from the tanker and insure its descent along the ladder.

When refueling the aircraft, it is necessary to be on the windward side in order to prevent fuel and lubricants from getting on unprotected parts of the skin.

Fuel sludge must be drained into a clean container, and after checking, pour it into a container intended for this.

It is strictly forbidden to drain sludge onto the filling site cover.

When top filling, it is necessary to use only ladders specially designed for this type of aircraft. Before starting work, it is necessary to make sure that the stepladder is firmly installed and cannot damage the aircraft when it settles from loading the fuel tanks. On high-lying parts of the aircraft, in order to avoid falling from a height, it is necessary to use safety belts.

The static electricity potential equalization pins provided on the dispensing taps and tips must be connected to the sockets on the fuel fillers and fittings of the aircraft before lowering the dispensing tap into the fuel tank filler neck (for top filling) or before docking the dispensing tip with the fitting of the centralized refueling system BC (with bottom filling).

In cases where the aircraft tank neck does not have a receiving socket, touch the aircraft skin with a pistol valve at a distance of at least 1.5 m from the fuel filler neck and only then insert the valve into the tank neck, pressing it firmly and without moving during the entire refueling.

Caps, hatches and plugs of filling fittings and necks of aircraft fuel tanks and refueling facilities should be opened only with a tool designed for this purpose, excluding sparking. It is forbidden to perform the specified work by striking.

To prevent the aircraft from overturning in the event of a possible critical change in the alignment, a safety hoist must be installed under the rear fuselage in the place provided. At the same time, fire-fighting measures must be taken in accordance with the requirements of the Fire Safety Rules in Ukraine and NPO GA-85 (section 2, paragraphs 49, 61 of these Rules).

5.3. Fire safety

Responsibility for the management of work to ensure fire safety, for its general and specific condition, for daily supervision and control over compliance with existing norms, rules and requirements for fire safety in civil aviation organizations and enterprises, in divisions and links, in brigades and groups that carry out maintenance and repair of AT, are borne by their managers (including the direct supervisors of the work performed at AT), within the limits of duties and powers established for each (by the documents of the enterprise and in accordance with regulatory enactments). The specified responsibility extends to the processes of production of maintenance and repair of aircraft in places of permanent and temporary basing of aircraft.

Employees of all categories and levels are required to know and comply with the norms, rules and requirements of fire safety established by regulatory documents.

The specific duties and powers of each employee on these issues are included in his job description.

In a typical case, in order to ensure the complexity of fire and preventive work in enterprises, fire and technical commissions are created to develop and monitor the implementation of relevant measures.

Permanent fire prevention measures include:

- organization and control of the implementation of existing norms, rules and requirements of fire safety by all categories of employees;

- ensuring a strict fire regime in production, administrative, warehouse and auxiliary premises. At the same time, in each case, smoking areas, the procedure for conducting hot work, inspection and closing of premises after completion of work must be determined;

- a clear definition by the documents of the enterprise of the composition of specific persons responsible for the fire safety of specific facilities;

- providing personnel with instructions on fire safety of objects and works, evacuation of people, aircraft and equipment in case of fire;

- ensuring the conduct of fire safety briefings with all employees and training in accordance with the programs of the fire and technical minimum, including practical training in the use of primary fire extinguishing equipment;

- continuous preventive work to effectively prevent violations of fire safety rules.

The composition of employees responsible for the fire safety of specific facilities is determined by the documents of the enterprise. The service details of these persons are given in the relevant signs installed at the facilities.

In a typical case, the employee responsible for the fire safety of the facility is obliged to:

- ensure compliance with the established fire regime at the facility;

- conduct fire-fighting briefing of personnel and classes on fire-technical minimum;

- monitor the serviceability of technological equipment, fixtures, heating, ventilation, electrical installations, the performance of work on the aircraft in strict accordance with fire safety rules and take immediate measures to eliminate detected fire hazardous malfunctions and shortcomings;

- supervise the actions of the subordinate staff to extinguish the fire with the available means;

- control the cleaning of MS from dry grass, debris, used rags, spilled oil products;

- monitor the timely cleaning of workplaces and premises, disconnecting the power supply (except for emergency lighting and electrical installations, which, under specific conditions, must be on);

- to ensure the maintenance in good condition and constant readiness for action of the fire extinguishing, communication and signaling equipment available at the facility.

For all employees of the EAS of the enterprise (organization) of the civil aviation, fire-fighting briefings are mandatory:

- introductory (when applying for a job);

- primary (at the workplace);

- periodic (twice a year in preparation for work in the spring-summer and autumn-winter periods).

Persons who have not passed the necessary briefings are not allowed to work.

In a typical case, to increase the efficiency of actions in the event of a fire, it is necessary:

- to provide workplaces for the dispatching staff, security services with a notification scheme and interaction of divisions when extinguishing a fire, means of communication with divisions and firemen on duty;

- in all production and office premises, in prominent places, place schemes for the evacuation of people, AT, documentation, equipment and property, and other actions necessary in case of fire.

It is prohibited to smoke at workplaces in industrial premises, hangars, warehouses, storage facilities, near and inside the aircraft, at AtoN storage sites, and in other fire hazardous places.

Smoking is allowed in specially equipped places equipped with fire extinguishing equipment. In places that are allowed or prohibited for smoking, standard signs are posted.

When storing, performing maintenance and repair of AT in open areas and indoors, it is prohibited:

- start work without checking the grounding of the aircraft, the availability and serviceability of fire extinguishing equipment;
- allow special vehicles and vehicles that do not have the means of fire extinguishing, grounding and spark extinguishing provided for them;
- use faulty electric heating and electric lighting devices and installations when working on the aircraft;
- carry out work on painting, washing and washing parts in rooms not equipped for this;
- store containers with combustible materials, kindle blowtorches, make fires, burn garbage, burn grass near the aircraft, industrial buildings and other objects (at distances less than established by the relevant documents);
- store flammable and combustible liquids, oxygen cylinders, oiled rags, vehicles in hangars, docks;
- wash and clean items of household equipment, aircraft parts and parts with flammable materials;
- drain oil products onto the soil (concrete, asphalt) and into unsuitable containers;
- when working in a hangar (premises), place electrical wires in the way of internal hangar transport;

- clutter up the ways of aircraft (equipment) withdrawal from the hangar (premises);

- use fire equipment (equipment) for other purposes.

Upon detection of a fire that has arisen, the employee is obliged to immediately inform the fire brigade on duty, the dispatcher, any manager and proceed to extinguish the fire with the available means.

Conclusions

A list of dangerous and harmful factors is given in the "Occupational safety" section that may arise when maintaining aircraft engines and working with fuels and lubricants.

Also, in this section, it was described how to properly maintain aircraft engines without endangering the life of the worker. What is the responsibility of both workers and private companies that do not follow fire safety rules.

CONCLUSIONS

As a result of the study of the method of diagnosing the flow part of an aviation TFE, the following results have been obtained:

In the first part was analyzed based on the characteristics of the GTE TV3-117, the main systems and components of the engine GTE TV3-117, considered the engine compressor, described the compressor surge, the cause of surge, the allowable damage standards of the compressor stage blades.

In the second part the questions of diagnostics of flowing parts of GTE have been considered, namely: malfunctions of flowing system, algorithms and features of diagnosing of flowing part of GTE, diagnosing of boundary amplitudes of oscillations of working blades of the compressor of GTE, diagnosing of a stressed condition of details of GTE by non-destructive methods.

In the third part the technical parameters of absolute pressure sensors of capacitive types DAE-12S and DAE-D were considered. Practical diagnostics of gas turbines and compressors have been held, namely: thermodynamic calculation of gas turbine engines, determining the parameters of the working body by the compressor, the determination of the parameters of the working body at the outlet of the combustion chamber, the determination of gas parameters by the turbine, turbodynamic calculation of turbojet engines with gas mixing by a free turbine, the determination of the main specific parameters of turbine engines, diagnosing the technical condition of gas compressor units by thermal

In the fourth part considered the issue Influence of air transport on the environment, such as: Impact of ground sources of air transport on the environment, The influence of air sources of air transport on the environment., Emissions of harmful substances during the operation of aviation refueling enterprises., Ways to reducing environmental hazards from emissions of oil vapors, Leakage of oil products on fuel supply enterprises and methods of their reduction.

In the fifth part the issues of Power plant maintenance, Aircraft refueling with fuels and lubricants and special liquids, fire safety.

RECOMMENDED LITERATURE

1. Patan K. Artificial Neural Networks for the Modelling and Fault Diagnosis of Technical Processes. Springer, 2008. doi: <https://doi.org/10.1007/978-3-540-79872-9>
2. Медведев В. С., Потемкин В. Г. Нейронные сети. Matlab 6. М.: ДИАЛОГ-МИФИ, 2002. 496 с.
3. Integrated Gas Turbine System Diagnostics: Components and Sensor Faults Quantification using Artificial Neural Network / Osiawe E., Yi-Guang L., Sampath S., Gbanaibolou J., Dieni I. // 23rd International Society of Air Breathing Engines (ISABE) Conference – ISABE 2017. Manchester, 2017. URL: https://www.researchgate.net/profile/Emmanuel_Osiawe/publication/319645027_Integrated_Gas_Turbine_System_Diagnostics_Components_and_Sensor_Faults_Quantification_using_Artificial_Neural_Network/links/59e52ae90f7e9b0e1aa888f0/Integrated-Gas-Turbine-System-Diagnostics-Components-and-Sensor-Faults-Quantification-using-Artificial-Neural-Network.pdf?origin=publication_detail
4. Loboda I. Gas Turbine Condition Monitoring and Diagnostics. Gas Turbines. 2010. P. 119–144. doi: <https://doi.org/10.5772/10210>
5. Loboda I., Feldshteyn Y., Ponomaryov V. Neural Networks for Gas Turbine Fault Identification: Multilayer Perceptron or Radial Basis Network? // Int. J. Turbo Jet-Engines. 2012. Vol. 29, Issue 1. P. 37–48. doi: <https://doi.org/10.1515/tjj-2012-0005>
6. Ismail R. I. B., Ismail Alnaimi F. B., AL-Qrimli H. F. Artificial Intelligence Application in Power Generation Industry: Initial considerations // IOP Conference Series: Earth and Environmental Science. 2016. Vol. 32, Issue 1. P. 012007. doi: <https://doi.org/10.1088/1755-1315/32/1/012007>
7. Кучер А. Г., Дмитриев С. А., Попов А. В. Определение технического состояния ТРДД по данным экспериментальных исследований с использованием нейронных сетей и методов распознавания образов // Авиационно-космическая техника и технология. 2007. № 10 (46). С. 153–164. URL: http://nbuv.gov.ua/UJRN/aktit_2007_10_34

8. Способ диагностики технического состояния газотурбинного двигателя: Пат. № 2445598С1 RU. № RU2010134067А; заявл. 13.08.2010; опубл. 20.03.2012, Бюл. № 8. URL: <http://www.freepatent.ru/patents/2445598>
9. Yildirim M. T., Kurt B. Aircraft Gas Turbine Engine Health Monitoring System by Real Flight Data // International Journal of Aerospace Engineering. 2018. Vol. 2018. P. 1–12. doi: <https://doi.org/10.1155/2018/9570873>
10. Evaluation of gas turbine diagnostic techniques under variable fault conditions / Pérez-Ruiz J. L., Loboda I., Miró-Zárate L. A., Toledo-Velázquez M., Polupan G. // Advances in Mechanical Engineering. 2017. Vol. 9, Issue 10. P. 168781401772747. doi: <https://doi.org/10.1177/1687814017727471>
11. Ntantis E. L., Botsaris P. N. Diagnostic Methods for an Aircraft Engine Performance // Journal of Engineering Science and Technology Review. 2015. Vol. 8, Issue 4. P. 64–72. doi: <https://doi.org/10.25103/jestr.084.10>
12. Fault Detection and Isolation of an Aircraft Turbojet Engine Using a Multi-Sensor Network and Multiple Model Approach / Nyulászi L., Andoga R., Butka P., Főző L., Kovacs R., Moravec T. // Acta Polytechnica Hungarica. 2014. Vol. 15, Issue 2. P. 189–209. doi: <https://doi.org/10.12700/aph.15.1.2018.2.10>
13. Ахмедзянов А. М., Дубравский Н. Г., Тунаков А. П. Диагностика состояния ВРД по термогазодинамическим параметрам. М.: Машиностроение, 1983. 206 с.
14. Ідентифікація математичної моделі авіаційного ГТД за польотними даними / Якушенко О. С., Мільцов В. Є., Чумак О. І., Корольов П. В., Охмакевич В. М. // Вісник двигунобудування. 2014. № 2. С. 130–138. URL: http://nbuv.gov.ua/UJRN/vidv_2014_2_23
15. Попов А. В., Степушкина Е. П., Слепухина И. А. Экспериментальное исследование характеристик ТРДД при перемежающихся повреждениях проточной части // Матеріали VIII Міжнародної науково-технічної конференції „ABIA – 2007”. Т. 2. К.: НАУ, 2007. С. 33.37–33.40. URL: <http://er.nau.edu.ua:8080/handle/NAU/36929>

16. Довідник працівника газотранспортного підприємства / Розгонюк В. В., Руднік А. А., Коломєєв В. М., Григіль М. А., Молокан О. О.; ред. А. А. Руднік. Київ: «Росток», 2001. 1092 с.

17. Нихмакин М. А., Зальцман М. М. Конструкция основных узлов двигателя ПС-90А. Пермь, 1997. 92 с.

1. Patan, K. (2008). Artificial Neural Networks for the Modelling and Fault Diagnosis of Technical Processes. Springer. doi: <https://doi.org/10.1007/978-3-540-79872-9>

2. Medvedev, V. S., Potemkin, V. G. (2002). Neyronnye seti. Matlab 6. Moscow: DIALOG-MIFI, 496.

3. Osigwe, E., Yi-Guang, L., Sampath, S., Gbanaibolou, J., Dieni, I. (2017). Integrated Gas Turbine System Diagnostics: Components and Sensor Faults Quantification using Artificial Neural Network. 23rd International Society of Air Breathing Engines (ISABE) Conference – ISABE 2017. Manchester. Available at: https://www.researchgate.net/profile/Emmanuel_Osigwe/publication/319645027_Integrated_Gas_Turbine_System_Diagnostics_Components_and_Sensor_Faults_Quantification_using_Artificial_Neural_Network/links/59e52ae90f7e9b0e1aa888f0/Integrated-Gas-Turbine-System-Diagnostics-Components-and-Sensor-Faults-Quantification-using-Artificial-Neural-Network.pdf?origin=publication_detail

4. Loboda, I. (2010). Gas Turbine Condition Monitoring and Diagnostics. Gas Turbines, 119–144. doi: <https://doi.org/10.5772/10210>

5. Loboda, I., Feldshteyn, Y., Ponomaryov, V. (2012). Neural Networks for Gas Turbine Fault Identification: Multilayer Perceptron or Radial Basis Network? Int. J. Turbo Jet-Engines, 29 (1), 37–48. doi: <https://doi.org/10.1515/tjj-2012-0005>

6. Ismail, R. I. B., Ismail Alnaimi, F. B., AL-Qrimli, H. F. (2016). Artificial Intelligence Application in Power Generation Industry: Initial considerations. IOP Conference Series: Earth and Environmental Science, 32 (1), 012007. doi: <https://doi.org/10.1088/1755-1315/32/1/012007>

7. Kucher, A. G., Dmitriev, S. A., Popov, A. V. (2007). Opredelenie tekhnicheskogo sostoyaniya TRDD po dannym eksperimental'nyh issledovaniy s ispol'zovaniem neyronnyh setey i metodov raspoznavaniya obrazov. Aviacionno-kosmicheskaya tekhnika i tekhnologiya, 10 (46), 153–164. Available at: http://nbuv.gov.ua/UJRN/aktit_2007_10_34
8. Pat. No. 2445598C1 RU. Diagnostic method of technical state of gas-turbine engine (2010). No. RU2010134067A; declared: 13.08.2010; published: 20.03.2012, Bul. No. 8. URL: <http://www.freepatent.ru/patents/2445598>
9. Yildirim, M. T., Kurt, B. (2018). Aircraft Gas Turbine Engine Health Monitoring System by Real Flight Data. International Journal of Aerospace Engineering, 2018, 1–12. doi: <https://doi.org/10.1155/2018/9570873>
10. Pérez-Ruiz, J. L., Loboda, I., Miró-Zárate, L. A., Toledo-Velázquez, M., Polupan, G. (2017). Evaluation of gas turbine diagnostic techniques under variable fault conditions. Advances in Mechanical Engineering, 9 (10), 168781401772747. doi: <https://doi.org/10.1177/1687814017727471>
11. Ntantis, E. L., Botsaris, P. N. (2015). Diagnostic Methods for an Aircraft Engine Performance. Journal of Engineering Science and Technology Review, 8 (4), 64–72. doi: <https://doi.org/10.25103/jestr.084.10>
12. Nyulászi, L., Andoga, R., Butka, P., Főző, L., Kovacs, R., Moravec, T. (2014). Fault Detection and Isolation of an Aircraft Turbojet Engine Using a Multi-Sensor Network and Multiple Model Approach. Acta Polytechnica Hungarica, 15 (2), 189–209. doi: <https://doi.org/10.12700/aph.15.1.2018.2.10>
13. Ahmedzyanov, A. M., Dubravskiy, N. G., Tunakov, A. P. (1983). Diagnostika sostoyaniya VRD po termogazodinamicheskim parametram. Moscow: Mashinostroenie, 206.
14. Yakushenko, O. S., Korolyov, P. V., Miltsov, V. E., Chumak, O. I., Ohmakevich, V. M. (2014). Identification of aviation gas turbine engine

mathematical model by operational data. *Visnyk dvyhunobuduvannia*, 2, 130–138.

Available at: http://nbuv.gov.ua/UJRN/vidv_2014_2_23

15. Popov, A. V., Stepushkina, E. P., Slepuhina, I. A. (2007). Eksperimental'noe issledovanie harakteristik TRDD pri peremezhayushchihsya povrezhdeniyah protochnoy chasti. *Materialy VIII Mizhnarodnoi naukovo-tekhnichnoi konferentsiyi „AVIA – 2007”*. Vol. 2. Kyiv: NAU, 33.37–33.40. Available at: <http://er.nau.edu.ua:8080/handle/NAU/36929>

16. Rozghoniuk, V. V., Rudnik, A. A., Kolomieiev, V. M., Hryhil, M. A., Molokan, O. O.; Rudnyk, A. A. (Ed.) (2001). *Dovidnyk pratsivnyka hazotransportnoho pidpryemstva*. Kyiv: «Rostok», 1092.

17. Nihmakin, M. A., Zal'cman, M. M. (1997). *Konstrukciya osnovnyh uzlov dvigatelya PS-90A*. Perm', 92.

