

**MINISTRY OF EDUCATION AND SCIENCE OF UKRAINE  
NATIONAL AVIATION UNIVERSITY**

Faculty of Aeronautics, Electronics and Telecommunications, Department of  
Aviation Computer-Integrated Complexes

**ACCEPT TO PROTECTION**

Head of Department

\_\_\_\_\_ Viktor SINEGLAZOV

“ \_ ” \_\_\_\_\_ 2023 y.

**QUALIFICATION PAPER  
(EXPLANATORY NOTE)  
HIGHER EDUCATION STUDY**

“MASTER”

Specialty 151 "Automation and computer-integrated technologies"  
Educational and professional program "Information support and engineering of  
aviation computer systems"

**Subject: Digital Barometric Altimeter**

Performer: student of the group I3-225M Viacheslav Dzhus

Supervisor: Associate professor, Mykola Vasylenko

Consultant of the "Environmental Protection" section \_\_\_\_\_ Radomska M.M.

Consultant of the "Occupational safety and health" section \_\_\_\_\_ Kazhan.K.I.

Norm control: \_\_\_\_\_ Fylashkin M.K.

**МІНІСТЕРСТВО ОСВІТИ І НАУКИ УКРАЇНИ**  
**НАЦІОНАЛЬНИЙ АВІАЦІЙНИЙ УНІВЕРСИТЕТ**  
Факультет аеронавігації, електроніки та телекомунікацій  
Кафедра авіаційних комп'ютерно-інтегрованих комплексів

**ДОПУСТИТИ ДО ЗАХИСТУ**

Завідувач випускової кафедри

\_\_\_\_\_ Віктор СИНЕГЛАЗОВ

“ \_\_\_ ” \_\_\_\_\_ 2023 р.

**КВАЛІФІКАЦІЙНА РОБОТА**  
**(ПОЯСНЮВАЛЬНА ЗАПИСКА)**  
**ВИПУСКНИКА ОСВІТНЬОГО СТУПЕНЯ**

“МАГІСТР”

Спеціальність 151 «Автоматизація та комп'ютерно-інтегровані технології»  
Освітньо-професійна програма «Інформаційне забезпечення та інженерія  
авіаційних комп'ютерних система»

**Тема: Цифровий барометричний висотомір**

Виконавець: студент групи ІЗ-225М Джус Вячеслав  
Ігорович

Керівник: доцент, Василенко Микола Павлович

Консультант розділу «Охорона навколишнього середовища» \_\_\_\_\_ Радомська М.М.

Консультант розділу «Охорона праці» \_\_\_\_\_ Кажан.К.І.

Нормоконтролер: \_\_\_\_\_ Філяшкін М.К.

НАЦІОНАЛЬНИЙ АВІАЦІЙНИЙ УНІВЕРСИТЕТ  
Факультет аеронавігації, електроніки та телекомунікацій  
Кафедра авіаційних комп'ютерно-інтегрованих комплексів

**Освітній ступінь:** Магістр

**Спеціальність:** 151 " Автоматизація та комп'ютерно-інтегровані технології"

**ЗАТВЕРДЖУЮ**

Завідувач кафедри

Віктор СИНЕГЛАЗОВ

“ \_\_\_\_\_ ” \_\_\_\_\_ 2023 р.

### **ЗАВДАННЯ**

**на виконання дипломної роботи студента**

Джуса Вячеслава Ігоровича

- 1. Тема проекту (роботи):** “ Цифровий барометричний висотомір”
- 2. Термін виконання проекту (роботи):** з 01.12.2023 р. до 27.12.2023 р.
- 3. Вихідні дані до проекту (роботи):** спосіб визначення висоти об'єкта, визначення тиску на поверхні, алгоритми калібрування датчиків та оточення Arduino IDE та Visual Studio
- 4. Зміст пояснювальної записки (перелік питань, що підлягають розробці):**
  1. Актуальність системи визначення висоти;
  2. Огляд існуючих систем визначення висоти;
  3. Огляд теоретичної інформації з приводу рішення задачі;
  4. Розробка барометричного висотоміра на основі МЕМС датчика.

**Перелік обов'язкового графічного матеріалу:** 1. Структурна схема барометричного висотоміра; 2. Блок-схема роботи датчика тиску; 3. Структурна схема барометричного висотоміра; 3. Графічний інтерфейс для барометричного висотоміра; 5. Таблиця перевірки точності, порівняння GPS висотоміра і цифрового висотоміра;

## 5. Календарний план-графік

№ пор.	Завдання	Термін виконання	Відмітка про виконання
1.	Отримання завдання	02.10.2023 – 03.10.2023	
2.	Формування мети та основних завдань дослідження	03.10.2023 – 05.10.2023	
3.	Аналіз існуючих методів	07.10.2023 – 15.10.2023	
4.	Теоретичний розгляд рішення задачі	17.10.2023 – 01.11.2023	
5.	Розробка структури цифрового барометричного висотоміра	01.11.2023 – 15.11.2023	
6.	Розробка програмного та апаратного забезпечення для цифрового барометричного висотоміра	20.11.2023 – 05.12.2023	
7.	Оформлення пояснювальної записки	07.12.2023 – 10.12.2023	
8.	Підготовка презентації та роздаткового матеріалу	12.12.2023 – 17.12.2023	

## 6. Консультанти з окремих розділів

Розділ	Консультант (посада, П.І.Б.)	Дата, підпис	
		Завдання видав	Завдання прийняв
Охорона праці	Доцент Катерина КАЖАН		
Охорона навколишнього середовища	Доцент Маргарита РАДОМСЬКА		

## 7. Дата видачі завдання: “2” жовтня 2023 р.

Керівник дипломної роботи \_\_\_\_\_

Микола ВАСИЛЕНКО

Завдання прийняв до виконання \_\_\_\_\_

Вячеслав ДЖУС

NATIONAL AVIATION UNIVERSITY

Faculty of aeronavigation, electronics and telecommunications

Department of Aviation Computer Integrated Complexes

**Educational level:** Master

**Specialty:** 151 "Automation and computer-integrated technologies"

**APPROVED**

Head of Department

Viktor SINEGLAZOV

" \_\_\_\_ " \_\_\_\_\_ 2023

**TASK**

**For the student's thesis**

Dzhus Viacheslav Igorovich

- 1. Theme of the project:** " Digital barometric altimeter"
- 2. The term of the project (work):** from December 01, 2023 until December 27, 2023
- 3. Output data to the project (work):** method of determining the height of the object, determining the pressure on the surface, algorithms for calibrating sensors, ArduinoIDE and Visual Studio environments.
- 4. Contents of the explanatory note (list of questions to be developed):**
  1. Relevance of the height determination system;
  2. Review of existing height determination systems;
  3. Review of theoretical information about the solution of the problem;
  4. Development of barometric altimeter based on MEMS sensor

**List of compulsory graphic material:**

1. Block diagram of the digital barometric altimeter; 2. Block diagram of the pressure sensor; 3. Block diagram of the barometric altimeter; 3. Graphical interface for barometric altimeter; 5. Accuracy check table, comparison of GPS altimeter and digital barometric altimeter;

## 5. Planned schedule:

<b>№</b>	<b>Task</b>	<b>Execution term</b>	<b>Execution mark</b>
1.	Task	02.10.2023 – 03.10.2023	
2.	Purpose formation and describing the main research tasks	03.10.2023 – 05.10.2023	
3.	Analysis of existing methods	07.10.2023 – 15.10.2023	
4.	Analysis of existing systems	17.10.2023 – 01.11.2023	
5.	Development of the structure of the image depth estimation system	01.11.2023 – 15.11.2023	
6.	Development of software and hardware for digital barometric altimeter	20.11.2023 – 05.12.2023	
7.	Making an explanatory note	07.12.2023 – 10.12.2023	
8.	Preparation of presentation and handouts	12.12.2023– 17.12.2023	

## 6. Consultants from individual sections

Section	Consultant	Date, signature	
		Issued the task	Accepted the task
Occupational safety and health	Associate Professor Kateryna KAZHAN		
Environmental protection	Associate Professor Margarita RADOMSKA		

## 7. Date of task receiving: “2” October 2023

Diploma thesis supervisor

(signature)

Mykola VASYLENKO

Issued task accepted

(signature)

Viacheslav DZHUS

## РЕФЕРАТ

Пояснювальна записка до дипломної роботи «Цифровий Барометричний висотомір»: 72 с., 30 рис., 2 табл., 7 літературних джерела.

**Об'єкт дослідження:** Цифровий Барометричний Висотомір.

**Мета роботи:** розробка та дослідження Цифрового Барометричного висотоміра.

Для досягнення цієї мети необхідно розв'язати наступні завдання:

- проаналізувати існуючі види висотомірів та їх недоліки;
- проаналізувати основні елементи цифрового барометричного висотоміра;
- розробити структуру цифрового барометричного висотоміра;
- розробити програмне та апаратне забезпечення реалізації обраного методу;
- провести експериментальне дослідження роботи розробленої системи.

**Предмет дослідження:** - розробка цифрового барометричного висотоміра

**Методи дослідження:** теоретична фізика, теоретична електроніка, теорія визначення висоти на основі тиску.

ЦИФРОВИЙ БАРОМЕТРИЧНИЙ ВИСОТОМІР; ДАТЧИК ТИСКУ;  
КАЛІБРУВАННЯ; МІКРОЕЛЕКТРОМЕХАНІЧНІ СИСТЕМИ.

## ABSTRACT

Explanatory note to the thesis "Digital Barometric Altimeter": 72 p., 30 figures, 2 tables, 7 literary resources.

**The object of research:** Digital Barometric Altimeter.

**The purpose of the work:** to develop and improve the real-time accuracy of a Digital Barometric Altimeter.

To achieve this purpose, it must be solved the following tasks:

- to analyze the existing types of altimeters, their strengths and weaknesses.
- to analyze the main parts of Digital Barometric Altimeter
- to develop the structure of a Digital Barometric Altimeter
- to develop software and hardware for the implementation of the selected method;
- to conduct an experimental study of the developed system.

**Subject of research:** development and research of Digital Barometric Altimeter

**Methods of research:** theoretical physics, theoretical electronics, theory of height determination based on pressure.

DIGITAL BAROMETRIC ALTIMETER; PRESSURE SENSOR;  
CALIBRATION; MICROELECTROMECHANICAL SYSTEMS.



## CONTENT

Glossary.....	
Introduction.....	
1. Relevance of the altitude exploration	
1.1 Background of altimeters and their applications	
1.2 Importance of accurate altitude measurement	
2. Contextual Framework	
2.1 Historical development of altimeters	
2.2 Overview of altimeters and their types	
2.3 Related works	
2.4 Key features and technologies used in digital barometric altimeters	
2.5 Recent advancements in altimeter technology	
3. Decoding MEMS Technology and Barometric Principles in Altitude Measurement	
3.1 Micro Electro Mechanical System (MEMS)	
3.2 Basic operations of MEMS	
3.3 Pressure Sensors based on MEMS	
3.4 Types of MEMS-Based Pressure Sensors	
4. Theoretical approach for solution of the problem	
4.1 Working Principle of Pressure Sensor	
4.2 Attributes of the Pressure Sensor	
4.3 Barometric formula	
5. An Experimental Approach of the stated problem	
5.1 Selection of Components for Device Assembly	
5.2 Barometric Altimeter Schematic Design	
5.3 Preparation of Components for Assembly	
5.4 Software Configuration for Assembled Mechanism	
5.5 Algorithm Implementation for Altitude Calculation	
5.6 Analysis and Evaluation of Errors and Accuracy Estimation	

## 6. Environment Protection

### 6.1 Key Components of Life Cycle Assessment

### 6.2 Equipment Description: Digital Barometric Altimeter

### 6.3 Environmental Impact at Each Life Cycle Stage

### 6.4 Comparison with Other Products

### 6.5 Recommendations for Minimizing Environmental Impact

### 6.6 Conclusions to Chapter

## 7. Occupational Safety and Health

### 7.1 Organization of the Engineer or Developer Workplace

### 7.2 Analysis of Hazardous Factors in the Workplace

### 7.3 Detailed Analysis of the Electrical Safety Factor in the Workplace

### 7.4 Fire Safety

### 7.5 Organizational and Technical Measures to Combat Harmful and Hazardous Factors

### 7.6 Conclusions to Chapter

Conclusions.....

References.....

## **GLOSSARY**

GPS — Global Positioning System

UAV — Unmanned Aerial Vehicle

BOE — Buffered Oxide Etchant

MEMS — Micro Electro Mechanical Systems

PPC - Piezoresistive Pressure Sensor

LCA - Life Cycle Assessment

GUI — Graphical User Interface

CVD — Chemical Vapor Deposition

## Introduction

In a world where we regularly traverse the complexities of aviation, venture into the great outdoors, manage finite resources with ever-growing demand, and even endeavor to predict the capricious behavior of the weather, altimeters emerge as unsung heroes, quietly and consistently serving as indispensable tools. These unassuming devices provide us with precise measurements of altitude or elevation above a reference point, a seemingly straightforward task that belies their profound significance.

At first glance, altimeters may appear unassuming, but their impact spans a multitude of fields and activities. From the boundless skies of aviation, where they play a critical role in guiding aircraft safely through the heavens, to the rugged landscapes of outdoor exploration, where they empower hikers and mountaineers, altimeters are steadfast companions that provide us with the precise knowledge of our vertical position on Earth.

To truly understand the significance of altimeters, we must harken back to the days of historical discovery. The foundations of these remarkable instruments can be traced to the groundbreaking work of Evangelista Torricelli, who unveiled the secrets of atmospheric pressure, and Lucien Vidi, who introduced the aneroid barometer. These pioneering discoveries laid the groundwork for altimeters, which have evolved from early mechanical devices into modern marvels that incorporate electronic sensors and satellite-based technology.

The altimeter stands as a symbol of our unwavering pursuit of precision and understanding.

## **CHAPTER 1. RELEVANCE OF THE ALTITUDE EXPLORATION**

### **1.1 Background of altimeters and their applications**

Altimeters, instruments crucial for measuring altitude above a reference point, have a rich history intertwined with diverse applications across various domains. From aviation to outdoor activities, altimeters play a pivotal role in providing accurate elevation information.

#### **Historical Evolution**

The inception of altimeters dates back to the early 17th century, with the barometer-based design by Evangelista Torricelli. Over time, altimeter technology has evolved from simple barometric devices to sophisticated electronic systems incorporating advanced sensors and microcontrollers.

#### **Aviation Applications**

In aviation, altimeters are fundamental for ensuring the safety and navigation of aircraft. They provide pilots with real-time altitude data, aiding in flight planning, navigation, and adherence to prescribed altitudes during ascent and descent.

#### **Outdoor and Recreational Use**

Beyond aviation, altimeters find applications in outdoor pursuits such as hiking, mountaineering, and geocaching. Outdoor enthusiasts rely on these instruments to navigate challenging terrains, track elevation changes, and enhance overall safety during their adventures.

#### **Scientific and Meteorological Significance**

Altimeters also contribute significantly to scientific research and meteorology. They play a key role in studying atmospheric conditions, weather patterns, and climate change. Satellite altimeters, for example, are instrumental in measuring sea surface heights and understanding ocean dynamics.

#### **Technological Advancements**

Recent advancements in altimeter technology have seen the integration of Micro Electro Mechanical Systems (MEMS) sensors, enhancing precision and reducing the size of these devices. Digital altimeters, equipped with sophisticated

algorithms and interfaces, have become increasingly common, offering improved accuracy and user-friendly features.

### **Significance of Altitude Accuracy**

The accuracy of altitude measurement holds paramount importance in various applications. Whether ensuring the safety of air travel, aiding in outdoor adventures, or contributing to scientific research, precise altitude data is indispensable.

In the subsequent sections of this document, we will delve deeper into the importance of accurate altitude measurement, the specific goals and scope of the diploma work, and the objectives driving the development of a digital barometric altimeter. This exploration aims to shed light on the historical context and multifaceted applications of altimeters, setting the stage for a comprehensive understanding of the subject matter.

### **1.2 Importance of accurate altitude measurement**

Accurate altitude measurement holds pivotal importance across a spectrum of applications, influencing safety, navigation, and decision-making in various fields. Understanding the significance of precise altitude data is paramount for appreciating the broader impact and relevance of altimeters.

#### **Aviation Safety and Navigation**

In aviation, maintaining the correct altitude is critical for safe flight. Altitude deviations can lead to collisions and pose serious risks. Altimeters provide pilots with real-time information, ensuring adherence to prescribed altitudes during takeoff, landing, and cruising.

Altitude measurements aid pilots in navigating over diverse terrains, including mountains and urban landscapes. Accurate readings prevent collisions with obstacles and ensure a safe flight path.

#### **Outdoor Activities and Exploration**

Outdoor enthusiasts rely on altimeters for navigation in challenging terrains. Accurate altitude data assists in identifying peak elevations, estimating climb difficulty, and planning routes.

Altitude information is crucial in search and rescue missions, guiding responders to specific locations and optimizing rescue strategies based on elevation.

### **Meteorological and Environmental Studies**

Altitude data contributes to meteorological models, enhancing the accuracy of weather predictions. It influences the understanding of atmospheric conditions, temperature variations, and precipitation patterns.

Studying altitude changes aids in climate change research, providing insights into shifts in temperature, ice cap melting, and sea level rise.

### **Aerospace Engineering and Space Exploration**

Altitude measurements are fundamental in plotting trajectories for spacecraft during launch, orbit, and re-entry. Precision is crucial for successful space missions.

Altitude data is essential for satellite positioning and communication. Satellite altimeters are used to measure sea surface heights, contributing to oceanographic research.

### **Surveying and Geospatial Applications**

Accurate altitude measurements contribute to creating detailed topographic maps. This is vital for urban planning, infrastructure development, and land surveying.

Geographic Information Systems (GIS) applications rely on precise altitude data to model and analyze geographical features, facilitating decision-making in fields such as urban planning and environmental management.

## **CHAPTER 2. CONTEXTUAL FRAMEWORK**

### **2.1 Historical development of altimeters**

For better understanding of altimeters we need to dive into its past. The roots of altimeters can be traced back to several historical developments and inventions related to measuring altitude and atmospheric pressure. Here are some key milestones in the development of altimeter technology:

#### **Mercury Barometer**

The altimeter's foundation lies in the invention of the mercury barometer by Evangelista Torricelli in the 17th century. Torricelli's work demonstrated that the height of a column of mercury in a sealed tube varied with changes in atmospheric pressure. This discovery provided the basis for measuring changes in altitude based on variations in atmospheric pressure.

#### **Aneroid Barometer**

Lucien Vidi, a Frenchman, invented the aneroid barometer in the mid-19th century. This device used a flexible metal chamber, or "aneroid cell," that would expand or contract with changes in atmospheric pressure. The movement of the aneroid cell was linked to a pointer, providing a visual indication of pressure changes. The aneroid barometer became a crucial component in early altimeter designs

#### **Digital Altimeters**

In the mid-20th century, electronic altimeters were developed, which replaced the mechanical components of earlier models with electronic sensors. These altimeters provided more precise and reliable altitude measurements and became standard equipment in modern aircraft.

#### **GPS Altimetry**

The Global Positioning System (GPS), developed in the latter half of the 20th century, revolutionized altimetry. GPS satellites provide highly accurate altitude



information, allowing for precise altitude measurements without relying solely on barometric pressure. GPS altimeters are now common in various applications, including aviation and outdoor navigation.

## Advancements in Sensor Technology

In recent years, advancements in sensor technology, including pressure sensors and accelerometers, have led to more compact and accurate altimeter designs. These sensors can be found in various devices, such as smartphones and wearables, making altitude information more accessible to the general population.

### 2.2 Overview of altimeters and their types

By analyzing the history and key points of altimeters, we can identify the following types:

#### 2.2.1 Barometric Altimeters



Fig. 2 Barometric Altimeter

Barometric altimeters measure altitude by detecting changes in atmospheric pressure as altitude varies. They use an aneroid cell or barometer to measure pressure.

#### Advantages:

- Precise and reliable in stable weather conditions.
- Commonly used in aviation and outdoor activities.
- Cost-effective and widely available.

### **Disadvantages:**

- Susceptible to atmospheric pressure changes caused by weather variations.
- Require periodic calibration to maintain accuracy.
- May not perform well in extreme weather conditions.

### **2.2.2 GPS Altimeters**



Fig. 2.1 GPS Altimeters

GPS altimeters determine altitude based on signals received from GPS satellites. They calculate altitude using satellite triangulation and can provide accurate readings in various conditions.

### **Advantages**

- Provide accurate altitude readings based on satellite signals.
- Not affected by atmospheric pressure changes.
- Suitable for both aviation and outdoor navigation.

## Disadvantages

- May require a clear line of sight to multiple GPS satellites, which can be obstructed in dense forests or urban canyons.
- Can consume significant battery power, especially in continuous use.
- Accuracy can be affected by signal interference or multipath errors.

### 2.2.3 Radar Altimetry



Fig. 2.2 Radar Altimeters

Radar altimeters use radio waves to measure altitude above the ground or water surface. They are commonly used in aviation for precise altitude measurements during takeoff and landing.

## Advantages

- Ideal for aviation, particularly during aircraft approach and landing phases.
- Provide precise measurements of altitude above the ground or water.
- Not affected by atmospheric pressure changes.

## Disadvantages

- Primarily used in aviation and not readily available for outdoor enthusiasts.
- Expensive and complex equipment.
- Limited to specific applications and not suitable for land-based navigation.

### 2.2.4 Laser Altimeters

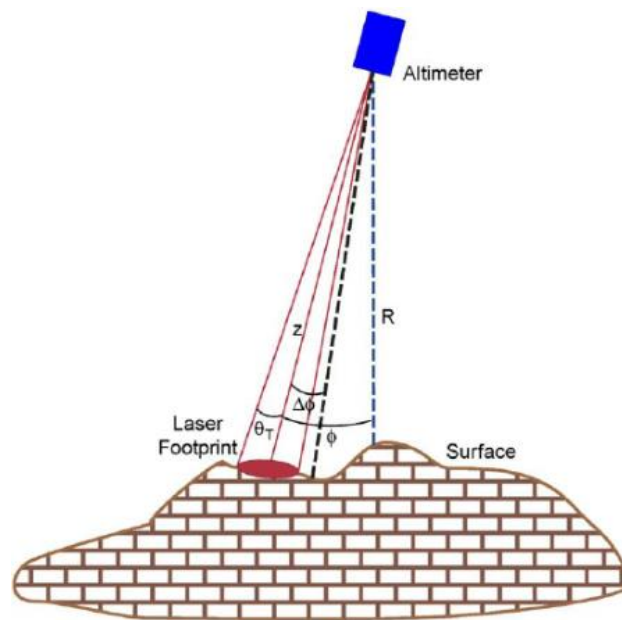

Fig. 2.3 Laser Altimeter

Laser altimeters emit laser pulses and measure the time it takes for the pulse to bounce back from the Earth's surface. They are used for high-precision altitude measurements in various applications, including geospatial mapping.

## Advantages

- Offer high-precision altitude measurements in various settings.
- Used in geospatial applications, such as topographic mapping.
- Not influenced by atmospheric pressure changes.

## Disadvantages

- Require a direct line of sight to the target surface, making them less suitable for rugged terrains or dense vegetation.
- Limited range compared to radar altimeters.
- Equipment cost and complexity can be barriers to widespread use.

### 2.2.5 Ultrasonic Altimeters



Fig. 2.4 Ultrasonic Altimeter

Ultrasonic altimeters emit sound waves and measure the time it takes for the sound waves to bounce back from a surface. They are used in fluid environments, such as water bodies, for depth sounding.

## Advantages

- Ideal for measuring altitude in fluid environments like water bodies.
- Used in applications such as depth sounding in marine navigation.
- Not affected by atmospheric pressure changes.

## **Disadvantages**

- Limited to specific applications, primarily in marine or underwater contexts.
- Accuracy can be affected by water conditions, such as turbulence or surface reflections.
- May not be suitable for land-based elevation measurements.

As we can see, modern altimeters have their drawbacks. Let's consider a digital altimeter. In the realm of altitude determination, where precision and reliability are paramount, the digital altimeter emerges as a superior and versatile solution. While various altimeter types offer unique advantages, the digital altimeter stands out as the pinnacle of modern altitude measurement technology, offering a comprehensive set of benefits that make it the best choice for a wide range of applications.

The digital altimeter combines the accuracy of barometric measurements with the advantages of digital technology, resulting in a powerful tool for altitude determination. It is immune to the vagaries of atmospheric pressure fluctuations that can affect traditional barometric altimeters, ensuring consistent and dependable altitude readings regardless of weather conditions.

One of the key advantages of digital altimeters is their ability to provide precise and real-time altitude data. With the integration of advanced sensors and algorithms, digital altimeters offer accuracy that meets the stringent demands of aviation, outdoor navigation, and scientific research. Pilots rely on digital altimeters for safe and reliable altitude readings during flights, hikers and climbers benefit from their accuracy in challenging terrains, and scientists trust them for precise environmental monitoring.

Digital altimeters also offer the advantage of versatility. They can be compact and integrated into various devices, including wristwatches, smartphones, and outdoor equipment. This portability makes them accessible to a wide range of users, from casual outdoor enthusiasts to professionals in diverse fields.

Furthermore, digital altimeters often include additional features such as GPS integration, which enhances their capabilities by providing accurate positioning information along with altitude data. This integration further bolsters their usefulness in navigation and geospatial applications.

In a rapidly evolving world where precision and real-time data are essential, the digital altimeter rises to the occasion, meeting the demands of modern users. Its immunity to atmospheric pressure changes, precision, versatility, and additional features make it the ideal choice for altitude determination across a broad spectrum of activities and industries.

As we navigate our ever-changing landscapes, from aviation to outdoor adventures, from scientific exploration to everyday life, the digital altimeter stands as the pinnacle of altitude measurement technology, offering us the precision, reliability, and flexibility needed to reach new heights, explore new horizon

### **2.3 Related works**

In the realm of altitude measurement and precision elevation tracking, digital altimeters [1] have emerged as vital instruments. These devices, equipped with advanced technology, play an essential role in diverse fields, from aviation to outdoor adventure, from scientific research to geospatial mapping.

In this collection of related works, we explore the significance, design, and applications of digital altimeters. These works shed light on the innovation, performance, and real-world utility of these remarkable instruments, providing insights into their impact on modern technology and various industries.

#### **Design and Development of a Portable Digital Altimeter**

This study focuses on the design and development of a portable digital altimeter. The research discusses the construction, calibration, and performance evaluation of the altimeter, emphasizing its potential applications in outdoor activities, navigation, and geospatial measurements.

## **Performance Analysis of MEMS-Based Digital Altimeters**

This research work evaluates the performance of MEMS (Micro-Electro-Mechanical Systems) based digital altimeters. It assesses the accuracy, precision, and reliability of altimeter readings obtained from MEMS pressure sensors and discusses their suitability for aviation and recreational purposes.

## **Digital Altimetry in Modern Avionics**

This work explores the role of digital altimeters in modern avionics. It discusses the integration of digital altimeters in aircraft instrumentation, highlighting their significance in aviation safety, navigation, and altitude control systems.

## **Smartphone-Based Digital Altimetry for Outdoor Enthusiasts**

This study investigates the use of digital altimeters in smartphones for outdoor enthusiasts. It assesses the accuracy and practicality of smartphone-based altimeters for hikers, climbers, and adventurers, emphasizing their benefits in real-time altitude tracking during outdoor activities.

## **Advancements in GPS-Integrated Digital Altimeters**

This research paper discusses the latest advancements in digital altimeters with integrated GPS technology. It explores how GPS-enhanced altimeters provide accurate altitude and location data, making them valuable tools for aviation, geospatial mapping, and scientific research.

## **Digital Altimeter Calibration and Accuracy Analysis**

This work focuses on the calibration and accuracy analysis of digital altimeters. It presents methodologies for calibrating altimeters to ensure their precision and discusses the factors affecting altimeter accuracy under various conditions and environments.



## **Applications of Digital Altimetry in Precision Agriculture**

This research explores the applications of digital altimetry in precision agriculture. It discusses how digital altimeters are used to monitor elevation variations in agricultural fields, aiding in irrigation management, drainage, and soil health assessments.

## **Digital Altimeters in Geological Surveying**

This study delves into the use of digital altimeters in geological surveying and terrain mapping. It highlights how altimeter data contributes to understanding land elevation changes, geological formations, and environmental shifts in scientific research and geological exploration.

### **2.4 Key features and technologies used in digital barometric altimeters**

Digital barometric altimeters [3] stand as technological marvels, encapsulating precision, miniaturization, and advanced features that redefine altitude measurement. Anchored by sophisticated barometric pressure sensors, often based on Micro Electro Mechanical Systems (MEMS) technology, these instruments deliver high-precision readings with temperature compensation mechanisms ensuring accuracy across varying environmental conditions.

MEMS technology [2], with its miniaturization prowess, enables the downsizing of altimeters while maintaining precision. The integration of accelerometers and gyroscopes contributes to overall functionality, with low power consumption making them suitable for portable devices. Digital Signal Processing (DSP) algorithms refine raw sensor data in real-time, compensating for environmental factors and sensor errors, enhancing the reliability of altitude measurements.

These altimeters feature calibration protocols, adjusting for variations in atmospheric pressure and ensuring accurate readings. User interfaces with intuitive displays, often employing LCD or OLED technologies, present altitude data clearly, with additional features like backlighting and customizable units enhancing user

experience. Some models even offer wireless connectivity, seamlessly integrating with devices for data logging and sharing.

Altimeter calibration software provides customization options, allowing users to fine-tune settings and calibration parameters based on specific needs. Together, these key features and technologies showcase the pinnacle of altitude measurement technology, making digital barometric altimeters indispensable tools across aviation, outdoor activities, and scientific research.

## **2.5 Recent advancements in altimeter technology**

As altitude measurement technology continues to evolve, recent advancements have propelled altimeters into new frontiers, with a particular focus on the integration of Micro Electro Mechanical Systems (MEMS).

The adoption of MEMS technology in altimeters has been a game-changer, offering a transformative shift in size, precision, and energy efficiency. Recent breakthroughs in MEMS-based altimeters include the miniaturization of components, such as accelerometers and gyroscopes, resulting in compact yet highly accurate instruments. These advancements have not only reduced the physical footprint of altimeters but have also enhanced their suitability for a broader range of applications.

One notable aspect of these recent advancements is the improved energy efficiency of MEMS-based altimeters, ensuring prolonged battery life and making them ideal for portable and wearable devices. Additionally, MEMS sensors contribute to the altimeters' ability to provide real-time data processing, enabling instantaneous and accurate altitude readings.

The integration of MEMS technology has facilitated the creation of altimeters with superior sensitivity to changes in atmospheric conditions. These altimeters can swiftly adapt to fluctuations in temperature and pressure, ensuring consistent and reliable altitude measurements across various environments.

Wireless connectivity options represent another notable advancement, allowing MEMS-based altimeters to seamlessly integrate with smartphones and other

devices. This connectivity not only enhances user convenience but also opens up opportunities for data logging, sharing, and more sophisticated applications.

Recent advancements in altimeter technology, particularly those centered around MEMS integration, mark a paradigm shift in altitude measurement. These innovations hold the promise of greater precision, improved energy efficiency, and expanded applications, making MEMS-based altimeters vital instruments in diverse fields, from aviation and outdoor activities to scientific research and beyond.

## CHAPTER 3. DECODING MEMS TECHNOLOGY AND BAROMETRIC PRINCIPLES IN ALTITUDE MEASUREMENT

### 3.1 Micro Electro Mechanical System (MEMS)

Micro-Electro-Mechanical Systems (MEMS) represent a groundbreaking technological frontier, embodying the integration of electrical, mechanical, and optical components on a miniature scale.

MEMS technology facilitates the creation of mechanical structures, sensors, actuators, and electronics at the microscale, ranging from a few micrometers to a few millimeters. Within this framework, microdevices of various designs and purposes emerge, created through modified microelectronics technologies, characterized by micron dimensions and the incorporation of mechanical moving parts.

Advantages of MEMS technology in altitude measurement abound:

**Miniaturization:** MEMS devices are incredibly small, enabling the development of compact and lightweight systems, advantageous in applications with critical space constraints.

**Low Power Consumption:** MEMS devices consume minimal power, making them ideal for battery-operated and portable devices, extending battery life and reducing the need for frequent recharging.

**High Precision:** MEMS technology allows for the fabrication of highly precise sensors and actuators, suitable for applications where accuracy is paramount, such as navigation, healthcare, and scientific research.

**Cost-Effectiveness:** Scalability and cost-effectiveness in production make MEMS technology accessible for a wide range of applications, including consumer products.

**Integration:** MEMS devices can integrate multiple functions into a single package, simplifying system design and enhancing overall efficiency.

**Reliability:** Known for robustness and long-term reliability, MEMS devices withstand challenging environmental conditions, making them suitable for rugged applications like automotive and aerospace.

**High Sensitivity:** MEMS sensors exhibit high sensitivity to various physical phenomena, allowing them to detect subtle changes in the environment or conditions.

**Versatility:** Spanning diverse applications, from accelerometers and gyroscopes in smartphones to pressure sensors in automotive systems, MEMS technology adapts to various industries.

**Real-Time Data:** MEMS sensors provide real-time data, enabling immediate feedback and decision-making in applications like navigation, robotics, and healthcare monitoring.

**Interdisciplinary Collaboration:** MEMS technology fosters collaboration across different fields, encouraging innovation and cross-pollination of ideas in electrical engineering, mechanical engineering, materials science, and microfabrication.

**Reduced Environmental Impact:** Through reduced power consumption and miniaturization, MEMS technology contributes to more energy-efficient devices, minimizing environmental footprint.

**Enhanced Functionality:** Ongoing evolution in MEMS technology leads to the development of innovative devices, such as MEMS-based microfluidic devices revolutionizing fields like medical diagnostics.

### **3.2 Basic operations of MEMS**

The meticulous fabrication of Micro-Electro-Mechanical Systems (MEMS) involves a sequence of steps, orchestrating the creation of miniature mechanical and electronic components on a microscale.

Commencing with substrate selection, materials such as silicon wafers, glass, polymers, or compound semiconductors are chosen based on application-specific requirements. The substrate undergoes thorough cleaning and preparation, followed by the application of a photoresist layer for subsequent etching steps.

Photolithography defines patterns on the substrate using ultraviolet light and a photomask. Etching processes, including wet etching for isotropic removal and dry etching for directional removal, sculpt the material according to the defined patterns.

Various materials, such as metals, insulators, and semiconductors, are deposited onto the substrate using techniques like chemical vapor deposition (CVD), physical vapor deposition (PVD), or spin coating. These deposited layers form the structural and functional components of the MEMS device.

Iterations of photolithography, etching, and deposition may unfold to create intricate, multilayered structures and components within the MEMS device. Sacrificial layers may be selectively removed after the device is complete, allowing moving parts to attain freedom. The MEMS device is then packaged in a protective casing.

Rigorous testing ensures the functionality, performance, and reliability of MEMS devices, covering electrical, mechanical, and environmental aspects. MEMS devices may seamlessly integrate with electronic components like microcontrollers, sensors, and interfaces, coalescing into comprehensive systems capable of various functions.

Post-testing and integration, a meticulous inspection identifies defects or issues. The MEMS devices are then packaged, often with connectors and protective coatings, ready for deployment across diverse applications.

### **3.3 Pressure Sensors based on MEMS**

MEMS-based pressure sensors are a type of micro-electro-mechanical system (MEMS) device designed to measure pressure or force with high precision and reliability. These sensors have a wide range of applications across various industries, including automotive, healthcare, aerospace, industrial automation, and consumer electronics.

MEMS-based pressure sensors operate on the principle of mechanical deformation caused by applied pressure. They consist of a micro-machined diaphragm or membrane that deflects in response to pressure changes. When pressure

is applied to the diaphragm, it bends, and this bending is converted into an electrical signal through various mechanisms, typically piezoresistive or capacitive.

MEMS technology allows for the creation of extremely small pressure sensors, making them ideal for applications where space is limited. They can detect very small changes in pressure, making them suitable for measuring subtle variations in pressure or force. These sensors offer high accuracy and precision in pressure measurement, which is essential in applications where precise data is critical. It can be designed to measure pressure across a broad range, from a few millibars to several bars or more.

MEMS-based pressure sensors are often robust and capable of withstanding harsh environmental conditions, including temperature extremes, shock, and vibration. They offer rapid response times, making them suitable for applications where real-time pressure monitoring is required.

### **3.4 Types of MEMS-Based Pressure Sensors**

#### **Piezoresistive Pressure Sensors**

These sensors rely on the piezoresistive effect, where the electrical resistance of certain materials changes in response to mechanical stress. When pressure deforms the diaphragm, it alters the resistance of embedded piezoresistive elements, generating an electrical signal proportional to the applied pressure. Piezoresistive pressure sensors find applications in a variety of fields, including industrial pressure measurement, automotive systems, and medical devices.

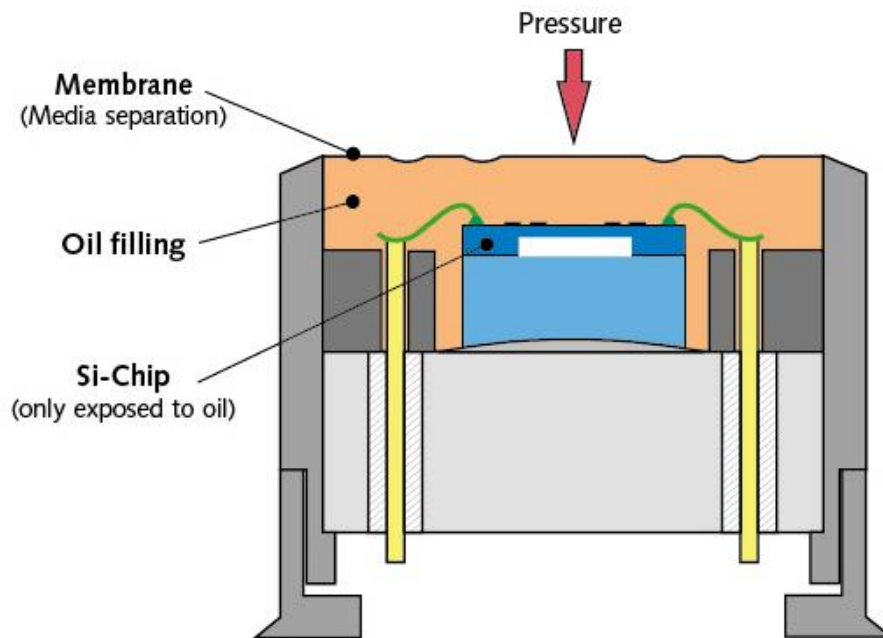

Fig. 3 Piezoresistive Pressure Sensor

### Capacitive Pressure Sensors

Capacitive pressure sensors utilize changes in capacitance between two plates one fixed and one movable (when pressure is applied). As the diaphragm moves in response to pressure, the capacitance changes, and this change is converted into an electrical signal. Capacitive pressure sensors are commonly used in precision applications, such as barometric pressure measurement, and can be found in consumer electronics and medical devices.



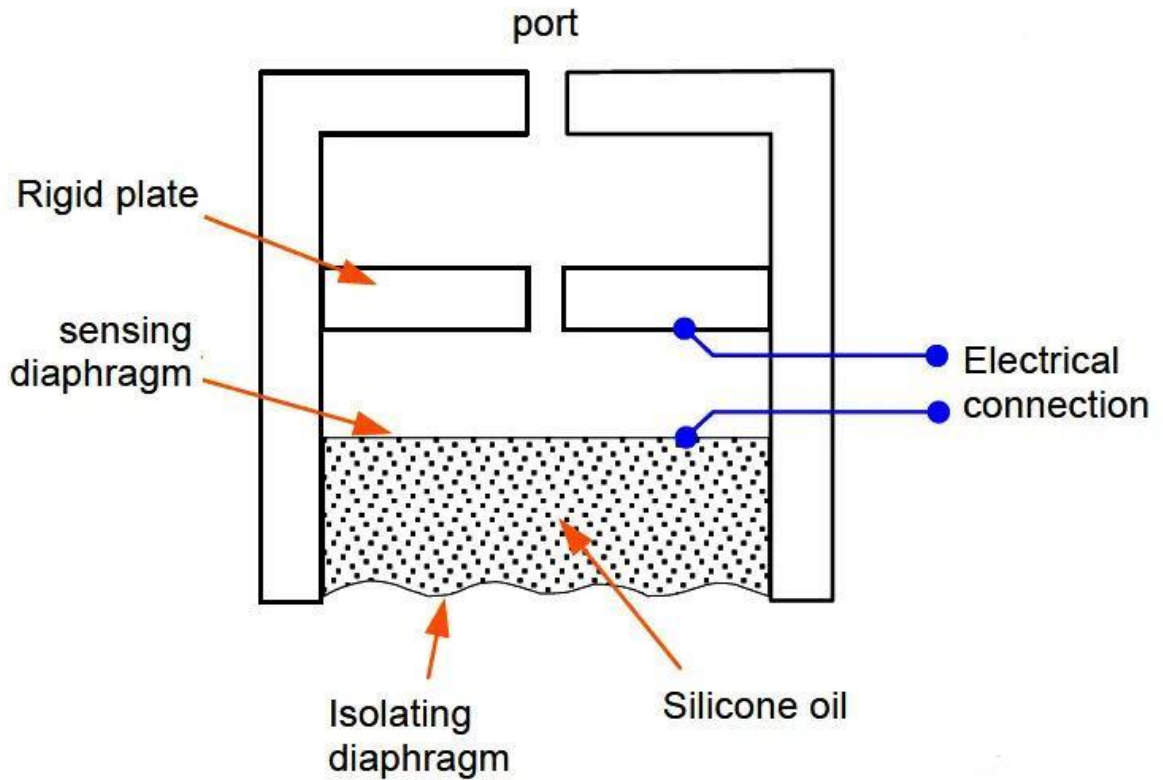

Fig. 3.1 Capacitive Pressure Sensor

### Surface Acoustic Wave (SAW) Pressure Sensors

SAW pressure sensors use the interaction of surface acoustic waves with a sensitive diaphragm. Pressure-induced deformation alters the frequency of the surface acoustic wave, allowing pressure to be measured. SAW pressure sensors are employed in demanding applications, including aerospace, where their high sensitivity and robustness are advantageous.

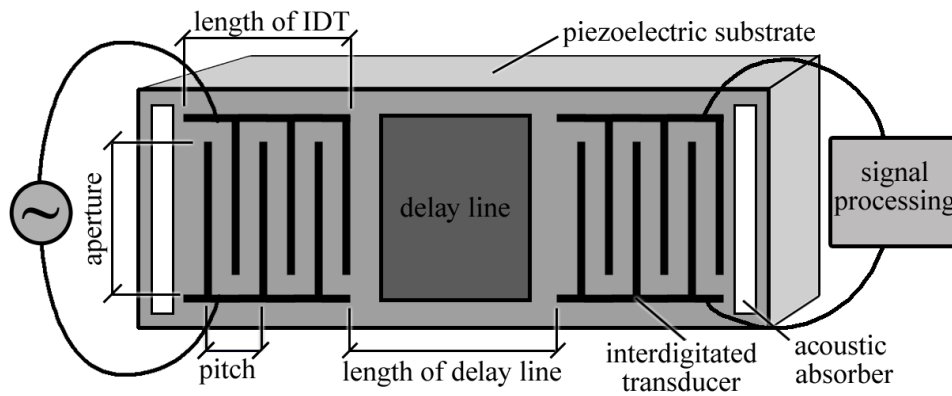

Fig. 3.2 Surface Acoustic Wave (SAW) Pressure Sensor

### Optical MEMS Pressure Sensors

Some MEMS pressure sensors use optical principles to measure pressure-induced changes in the reflection or transmission of light. Changes in pressure cause alterations in the optical properties, which are then detected and converted into pressure readings. Optical MEMS pressure sensors are used in applications where high accuracy and sensitivity are crucial, such as medical instrumentation and environmental monitoring.

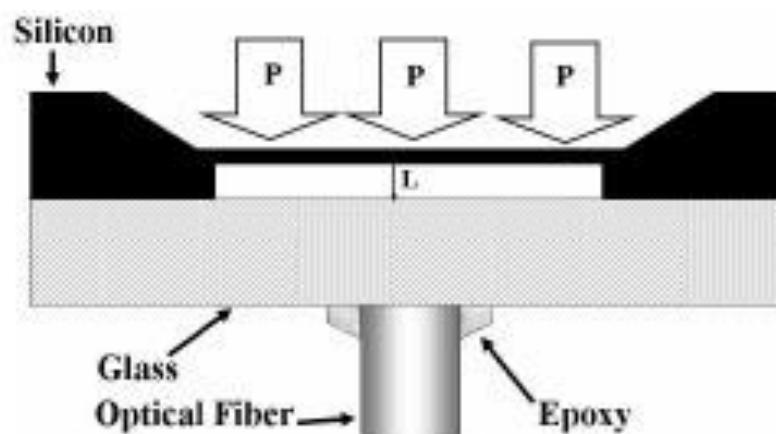

Fig. 3.3 Optical MEMS Pressure Sensor

## CHAPTER 4. THEORETICAL APPROACH FOR SOLUTION OF THE PROBLEM

### 4.1 Working Principle of Pressure Sensor

Micromechanical pressure sensors [4] are widely employed in various electrical designs, with two primary categories: differential and absolute pressure sensors. The fundamental structures of absolute and differential pressure sensors share similarities, particularly in their base housings. Let's explore the detailed construction of the base housing.

The central component of the pressure sensor is a crystal housing a silicon diaphragm featuring an embedded sensitive element equipped with a strain gauge chain. The distinction between the crystals in differential and absolute pressure sensors lies in the absence of a hole in the lower sealing silicon wafer for the latter.

Instead, a vacuum reference pressure is maintained in the etched cavity above the wafer. The internal space of the housing is filled with silicone gel, providing insulation for the crystal surface and joints while permitting pressure to influence the diaphragm. This design shields the device from environmental hazards, ensuring its optimal functionality.

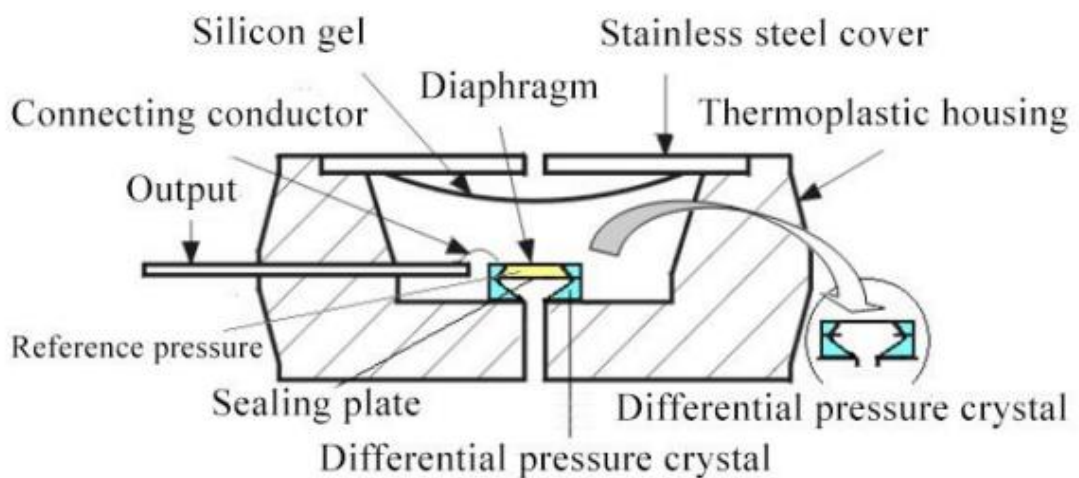

Fig. 4 Fundamental Structure of the Pressure Sensor

Exploring the integrated piezoresistive MEMS barometric pressure gauge BMP280, the pressure sensor's crystal is situated on a silicon crystal holder affixed to the sensor housing. Encased in a plastic housing featuring one or two supply ports, it is sealed with a stainless steel lid. External terminals, connected to the crystal sensor output terminals via gold wiring, are integrated into the housing.

The BMP280, akin to its predecessor BMP180, operates as a piezoresistive MEMS [7] sensor specifically designed for barometric pressure measurement. The BMP280 board incorporates not only the sensor but also a linear voltage stabilizer with capacitors and I2C bus power supply resistors. This sensor, like the BMP180, undergoes calibration [6] and includes a temperature compensation circuit. Calibration coefficients (11 coefficients) are stored in the sensor's built-in EPROM memory.

Beyond pressure readings, the BMP280 provides ambient temperature information. Operating in various modes, including standard, low power, high, and ultra-high power modes, the sensor is managed by a microprocessor control device, such as an Arduino controller in our case.

Upon connecting the sensor, library installation becomes necessary for interfacing with the BMP280 sensor. While some libraries are already part of the Arduino development environment, others, such as publicly available software algorithms from Bosch Sensortec, can be downloaded from various sources.

The BMP280 library encompasses files for calibration, temperature compensation, and algorithms for calculating absolute height. During software initialization, the microcontroller retrieves calibration coefficients from the BMP280's built-in EPROM memory. Subsequently, in an iterative cycle, pressure and temperature measurements commence. The processor reads "raw" temperature sensor UT and UP pressure readings through the I2C interface. Employing a specialized algorithm, it utilizes calibration factors and temperature values for temperature compensation, yielding true temperature (t) and pressure (P) values.

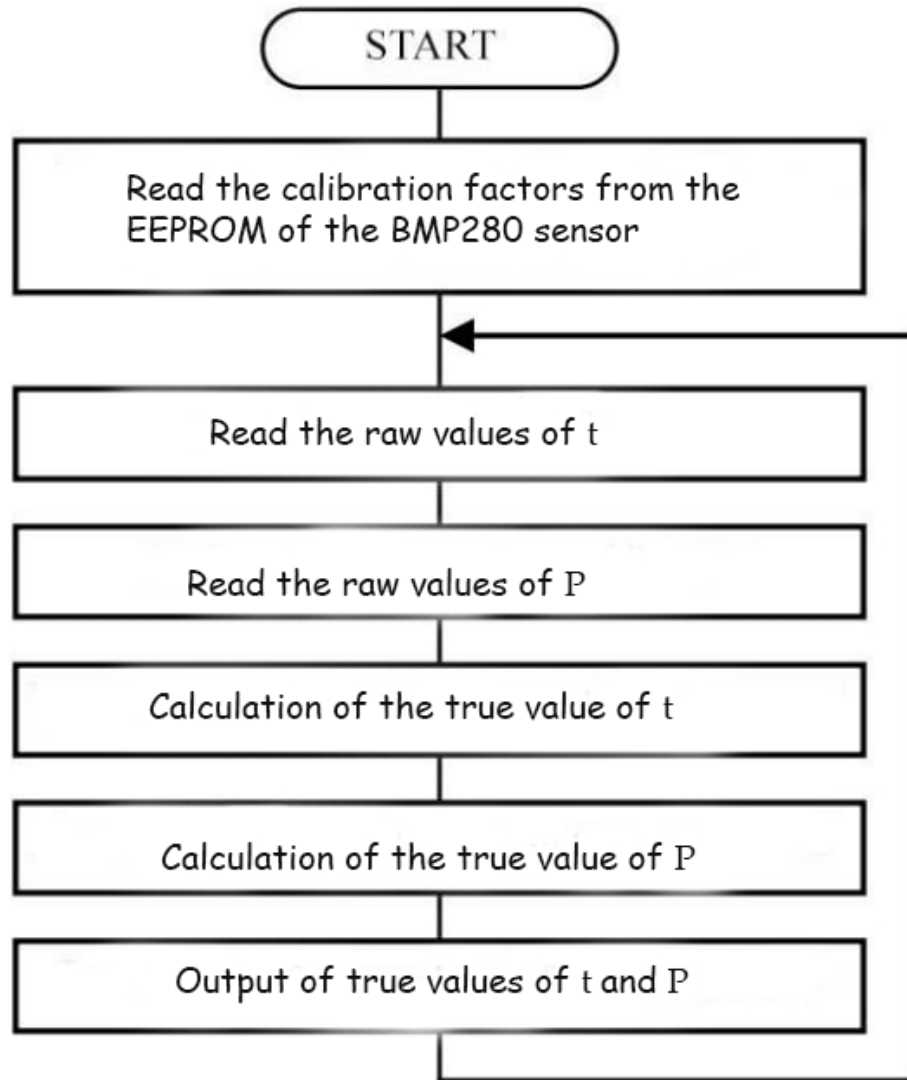

Fig. 4.1 BMP280 principle work

In standard mode, the BMP280 achieves a sampling rate of 128 measurements per second. This allows for temperature measurement once per second, with the value applied to all high pressures during the same period. Piezoresistive MEMS pressure sensors, exemplified by the BMP280, have found extensive use in aviation, particularly on small UAVs [5], serving as crucial instruments for measuring atmospheric pressure—the foundational element for calculating barometric altitude based on static pressure ( $P_{st}$ )

## 4.2 Attributes of the Pressure Sensor

The BMP280 is an absolute barometric pressure sensor intended specifically for mobile use.

The sensor module is packaged in an 8-pin metal-lid LGA box with a footprint of only 2.0 x 2.5 mm<sup>2</sup> and a package height of only 0.95 mm. It has a tiny size and low power consumption of 2.7A, 1Hz make it suitable for use in battery-powered devices such as cell phones, GPS modules, watches, and especially for small UAVs.

The BMP280, as the successor to the widely used BMP180, provides excellent performance in all applications requiring accurate pressure measurement. The BMP280 has a 63 percent smaller footprint than the BMP180 and offers reduced noise, additional filter modes, and an SPI interface.

### BMP280 Series Features & Benefits

- Tight absolute accuracy of  $\pm 1$  hPa & relative accuracy of  $\pm 0.12$  hPa
- I2C, SPI digital interface available
- Low current consumption: 2.7  $\mu$ A at 1 Hz sampling rate
- RoHS compliant and Halogen-free
- Tiny 8-pin package saving design place as most as possible
- Wide pressure sensing range: 300~1100 hPa
- 1.5 Pa/K offset temp coefficient (25~40°C, 900 hPa)

### BMP280 Outline Dimension and Block Diagram

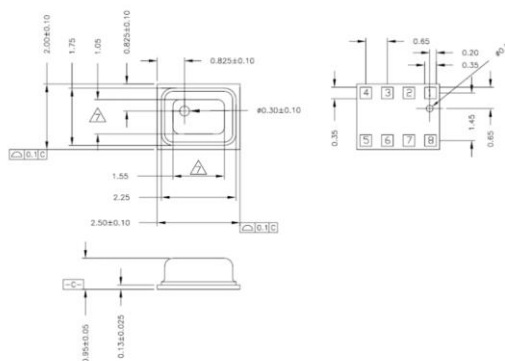

Fig. 4.2 BMP280 scheme

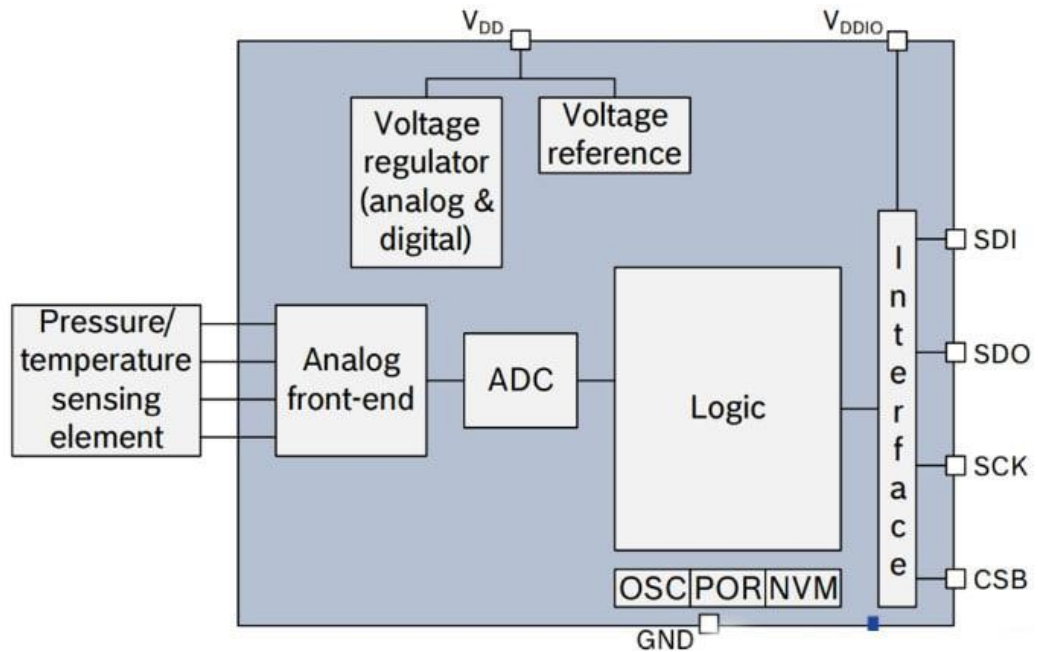

Fig. 4.3 BMP280 block diagram

The BMP280 stands out as a preferred module for various reasons. Its unparalleled precision in atmospheric pressure measurement surpasses many market alternatives. With significantly lower power consumption, the BMP280 is an optimal choice for battery-operated systems like smartwatches and mobile phones. Boasting high-speed communication capabilities via a TWI interface, it distinguishes itself by incorporating altitude measurement, a high-speed sensor, and an onboard temperature sensor.

While connecting to the BMP280 module proves user-friendly, complexities arise in data exchange between the ARDUINO controller and the module. Navigating a protocol becomes essential for error-free information transfer, posing challenges for beginners. To streamline communication, leveraging pre-written libraries designed for the module is ideal. Downloading and calling these libraries simplifies the process, with ARDUINO automatically adhering to the protocol and decoding requisite data once the header file is enabled. This approach ensures the BMP280 module's convenient utilization, making it accessible for a wide range of applications.

### 4.3 The barometric formula

The barometric formula, also known as the barometric altitude formula or simply the barometric equation, is a mathematical expression that describes how atmospheric pressure decreases with altitude. It is a fundamental tool in atmospheric science, meteorology, and aviation for estimating altitude based on atmospheric pressure.

The barometric formula is given by the following equation:

$$P(h) = P_0 \left(1 - \frac{Lh}{T_0}\right)^{\frac{gM}{RL}}$$

Where:

- $P(h)$  is the pressure at altitude  $h$
- $P_0$  is the pressure at sea level (standard atmospheric pressure)
- $L$  is the temperature lapse rate,  $h$  is the altitude
- $T_0$  is the standard temperature at sea level
- $g$  is the acceleration due to gravity
- $M$  is the molar mass of Earth's air
- $R$  is the universal gas constant

To calculate altitude from the atmospheric pressure using the barometric formula, you would rearrange the formula to solve for altitude ( $h$ ):

$$h = \frac{T_0}{L} \left(1 - \left(\frac{P(h)}{P_0}\right)^{\frac{gM}{RL}}\right)$$



This formula allows you to estimate the altitude based on the observed atmospheric pressure, assuming the temperature lapse rate ( L ) is constant. In reality, the lapse rate varies with altitude and weather conditions, so the barometric formula provides a simplified model.

The derivation of the barometric formula involves applying the ideal gas law to a column of air and considering the hydrostatic equilibrium. A full derivation can be complex and involves integrating differential equations. Here's a simplified outline.

**Hydrostatic Equilibrium:**

$$\frac{dP}{dh} = -\rho g$$

**Ideal Gas Law:**

$$PV = nRT$$

Where:

- n is the number of moles
- R is the gas constant
- T is the temperature

**Relating Pressure and Density:**

$$\rho = \frac{P}{RT}$$

**Substitute into Hydrostatic Equilibrium:**

$$\frac{dP}{dh} = -\frac{Pg}{RT}$$

**Integration and Simplification:**

This involves integrating the equation and making some assumptions, leading to the final barometric formula.

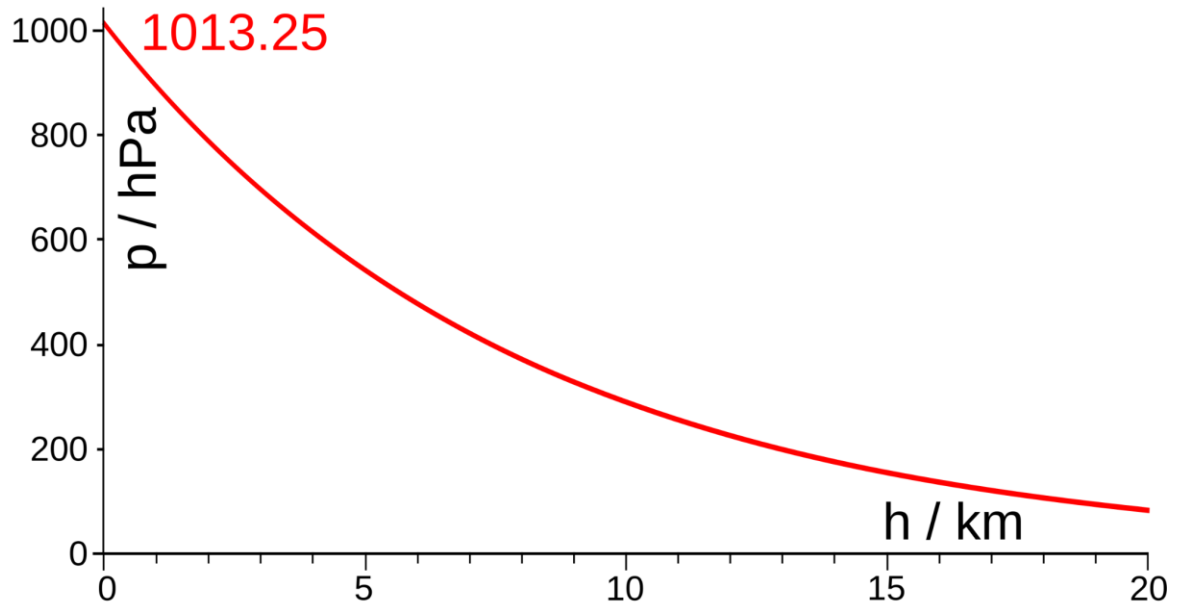

Fig. 4.4 Pressure as a function of the height above the sea level

## **CHAPTER 5. AN EXPERIMENTAL APPROACH OF THE STATED PROBLEM**

### **5.1 Selection of Components for Device Assembly**

Precision and compact design stand out as key attributes of a proficient altimeter. The effectiveness and dependability of individual components significantly influence altimeter development. Now, let's delve into the specifics of the altimeter assembled for this project.

The selected elements for my assembly include:

- Arduino NANO
- BMP280 Pressure Sensor
- MB102 Breadboard
- Oled Display 128x64
- Set of Jumpers
- USB Cable (Arduino Type, AM-Mini USB)

Having previously discussed the pressure sensor, let's proceed to the next aspect.

#### **Arduino Nano**

The Arduino Nano is a compact and versatile microcontroller board that is part of the Arduino family. It is designed for projects where space and size are crucial factors, making it suitable for various applications ranging from DIY electronics to prototyping.

The heart of the Arduino Nano is its microcontroller. The original Arduino Nano models used the ATmega328P microcontroller, the same chip found in the Arduino Uno. However, newer versions might incorporate different microcontrollers for enhanced performance.



Fig. 5 Arduino Nano

The Nano is characterized by its small form factor, making it ideal for projects with space constraints. Its compact size allows it to be easily integrated into projects where size matters.

The Nano comes with a set of digital and analog pins that allow for connecting various sensors, actuators, and other electronic components. The number and arrangement of pins resemble those of the Arduino Uno, providing compatibility with a wide range of shields and modules.

Arduino Nano typically features a USB port for programming and power supply. The USB connection is used to upload sketches (Arduino programs) from a computer to the Nano. It can also be powered through the USB connection.

The Nano includes a voltage regulator, allowing it to be powered with a wider range of voltages. This feature enhances flexibility when choosing a power source for your projects.

Some Arduino Nano boards come with integrated components such as LEDs, buttons, and resistors, which can be useful for basic experimentation and debugging.

Arduino Nano is widely used in projects where space is a critical consideration, such as wearable electronics, small robots, sensor nodes, and educational projects.

Table 5: Tech specs of Arduino Nano

Microcontroller	ATmega328
Architecture	AVR
Operating Voltage	5 V
Flash Memory	32 KB of which 2 KB used by bootloader
SRAM	2 KB
Clock Speed	16 MHz
Analog IN Pins	8
EEPROM	1 KB
DC Current per I/O Pins	20 mA (I/O Pins)
Input Voltage	7-12V
Digital I/O Pins	22 (6 of which are PWM)
PWM Output	6
Power Consumption	19 mA
PCB Size	18 x 45 mm
Weight	7 g
Product Code	A000005

All in all, Arduino Nano is a powerful yet compact microcontroller board, well-suited for projects that demand a small footprint while retaining the capabilities of a traditional Arduino platform. Its versatility makes it a popular choice among hobbyists, students, and professionals working on a diverse range of electronic projects.

#### MB102 Breadboard

The MB102 Breadboard is a widely used and versatile prototyping tool designed for creating temporary electronic circuits. It is particularly popular in the Arduino community for experimenting with and testing various electronic components before finalizing a permanent circuit.

It is typically constructed with a plastic base and a grid of interconnected metal clips or sockets. The board allows for easy insertion and connection of electronic components without the need for soldering.

The board is divided into rows and columns, providing a grid of interconnected points. Each row usually contains five terminals, and each column has ten terminals, making it convenient for organizing components in a systematic manner.

The MB102 often features dual terminal strips on both sides, allowing for flexibility in component placement. These strips are used for connecting power, ground, and other signals.

The breadboard typically includes two power rails, one for connecting positive (+) and the other for negative (-) or ground. These power rails run parallel to the length of the board, facilitating easy distribution of power to various sections of the circuit.

One of the key advantages of the MB102 Breadboard is its solderless design. Components can be easily inserted and removed without the need for soldering, making it an excellent tool for educational purposes and quick prototyping.

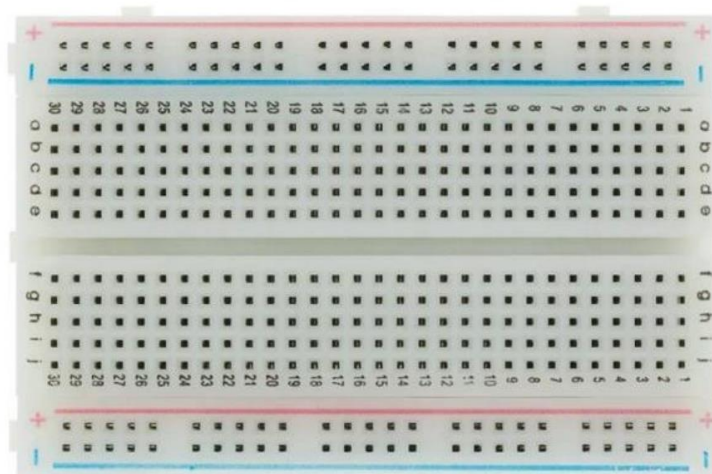

Fig. 5.1 MB102 Breadboard

In summary, the MB102 Breadboard serves as an invaluable tool in the world of Arduino and electronics prototyping, providing a convenient and flexible platform for designing and testing circuits without the need for soldering. Its ease of use, versatility, and compatibility with Arduino make it a staple in maker spaces, classrooms, and electronics workshops.

### Oled Display 128x64

The 128x64 OLED (Organic Light-Emitting Diode) display is a compact and versatile screen commonly used with Arduino microcontrollers. It provides a visually appealing and energy-efficient solution for displaying information in various electronic projects.

The "128x64" designation refers to the pixel resolution of the OLED display. It consists of 128 columns and 64 rows of pixels, providing a total of 8192 individual pixels for creating graphics, text, and other visual elements

Unlike traditional LCD displays, OLEDs use organic compounds that emit light when an electric current is applied. This technology offers advantages such as better contrast ratios, faster response times, and wider viewing angles.

Most 128x64 OLED displays are monochrome, typically featuring white pixels on a black background. While they lack color, monochrome OLEDs offer high contrast and are well-suited for displaying text and simple graphics.

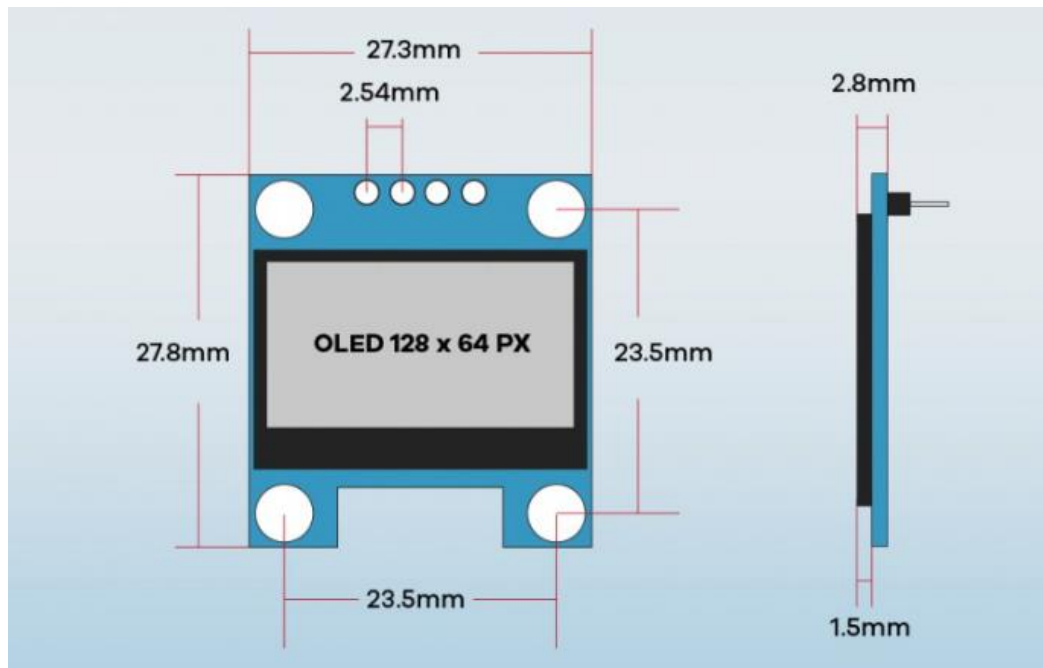

Fig. 5.2 Oled Display 128x64

These displays often use I2C or SPI communication protocols to connect with Arduino microcontrollers. This simplifies the wiring and allows for easy integration into projects.

The 128x64 OLED display is widely used in various Arduino projects, including weather stations, fitness trackers, smartwatches, electronic gadgets, and DIY instrumentation. Its versatility makes it adaptable to a wide range of applications.

128x64 OLED display is a popular choice for Arduino enthusiasts and electronic hobbyists due to its compact size, high contrast, low power consumption, and ease of integration. Its ability to display information in a visually appealing manner makes it a valuable component for a diverse range of electronic projects.

#### Set of Jumpers

Jumpers are short wires with connectors at each end used for establishing electrical connections between various points on a breadboard or between components and microcontrollers like Arduino.

Jumpers are classified in 3 types:



Male-to-Male Jumpers: These have pins at both ends, and they are commonly used for connecting components on a breadboard or linking pins on different devices.

Male-to-Female Jumpers: One end has pins (male), while the other end has receptacles (female). These are useful for connecting components to a breadboard or extending the reach of a male pin.

Female-to-Female Jumpers: Both ends have receptacles. These are often used when a direct connection between two female pins is required.



Fig. 5.3 Types of Jumpers

Jumpers come in various lengths and colors, allowing for organization and clarity in complex circuits. Short jumpers are suitable for close connections, while longer ones offer flexibility in larger circuits.

Jumpers are a fundamental tool for connecting different components on a breadboard. They help create the electrical pathways required for the circuit to function as intended.

### Cable AM-Mini USB

The USB cable with Arduino-compatible connectors, specifically featuring a Type-A Male (AM) plug on one end and a Mini USB plug on the other, serves as a vital link in electronic projects and Arduino development.

The USB cable is designed to establish a connection between an Arduino board and a computer or power source, facilitating data transfer, programming, and power supply.



Fig. 5.4 AM-Mini USB

## 5.2 Barometric Altimeter Schematic Design

Now that we've gained insights into the functioning of each component, we can proceed to construct a barometric altimeter circuit based on the received data.

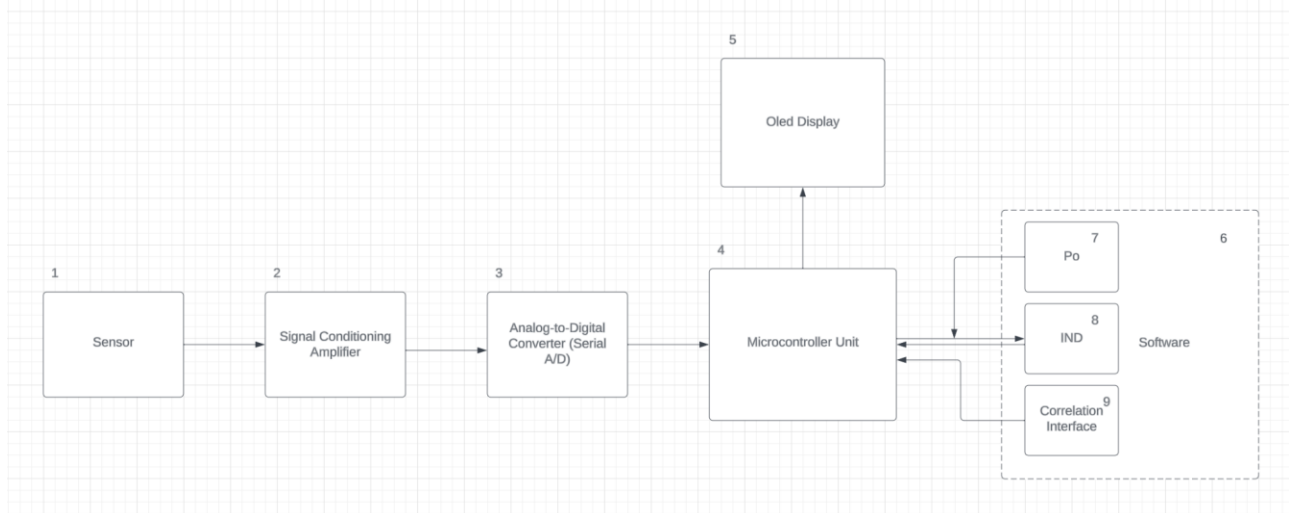

Fig. 5.5 Altimeter Schematic Design

1. Sensor
2. Signal Conditioning Amplifier
3. Analog-to-Digital Converter (Serial A/D)
4. Microcontroller Unit
5. Oled Display
6. PC Software
7. Ground Pressure Input
8. External Display Indicator (Remote Indicator)
9. Correlation Interface

Although the scheme may appear straightforward at first glance, it demands meticulous attention during assembly. Precision is crucial to prevent potential issues such as sensor or display burnouts that may occur if pins are incorrectly connected. Exercise caution while interconnecting specific components

## 5.3 Preparation of Components for Assembly

In practice, assembling a digital barometric altimeter involves physically arranging and connecting various components. The tangible representation of this

process includes combining elements such as the pressure sensor, microcontroller, display, power supply, connectors, and enclosure. This hands-on construction is essential for creating a functional altimeter that can accurately measure atmospheric pressure and display corresponding altitude readings.

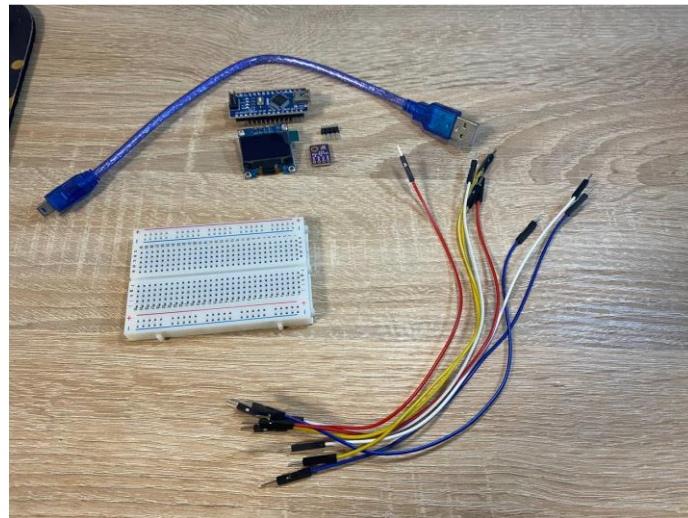

Fig. 5.6 Altimeter Components

Commence the assembly process by securing the breadboard in place. Extract the BMP280 and position it on the breadboard. Establish connections on the sensor platform by linking the designated points on the board.

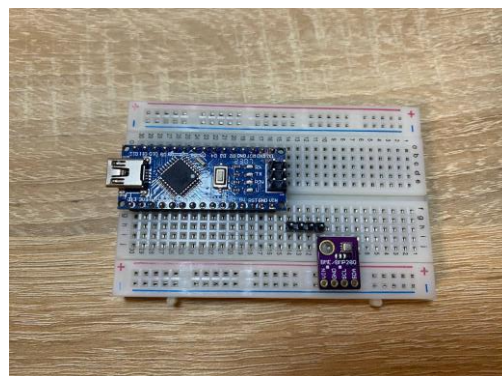

Fig. 5.7 BMP280 to board connection

Proceed with a similar procedure for the display. Once the display and pressure sensor are in place, the next step involves connecting them. Employ a set of male-to-male jumper wires for this purpose. The final component to integrate is the Arduino Nano. Exercise caution during the connection process, ensuring precision,

as incorrect placements may lead to the potential risk of burning out your components.

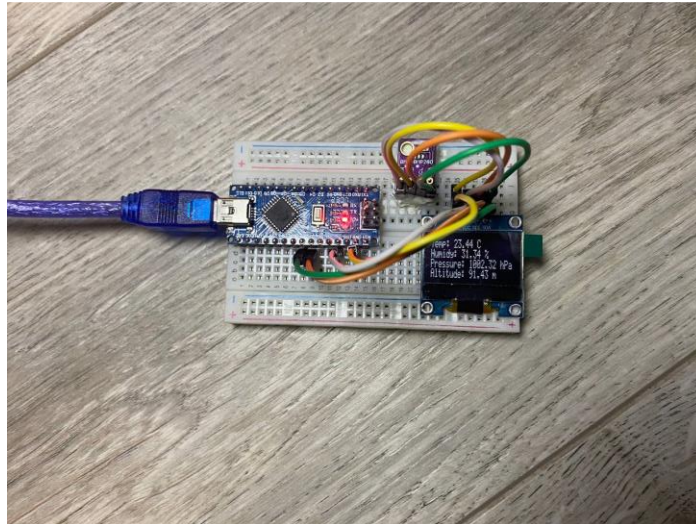

Fig. 5.8 Assembled Digital Barometric Altimeter

#### **5.4 Software Configuration for Assembled Mechanism**

Upon completing the physical assembly of our altimeter, the next crucial step is the software development. We'll be utilizing the Arduino IDE to program the Arduino Nano and Windows Forms for the graphical user interface.

In the Arduino IDE, you'll craft the code that reads data from the BMP280 pressure sensor and communicates it to the display. Make sure to include any necessary libraries for the sensor.

Simultaneously, for the user interface, Windows Forms provides a versatile platform. Through this framework, you can design a graphical interface for users to interact with the altimeter. This might include displaying real-time altitude data, implementing calibration options, or any additional features you wish to incorporate.

Remember, the integration between the Arduino code and Windows Forms is vital. The Arduino code should send relevant data to the Windows Forms application, and the interface should be designed to receive and display this information accurately.

As you progress with the software development, ensure compatibility between the Arduino code and the Windows Forms application. Thoroughly test the software to guarantee seamless communication between the hardware and the user interface, providing a comprehensive and functional digital barometric altimeter experience.

## 5.5 Algorithm Implementation for Altitude Calculation

Having gathered all the information and theoretical knowledge, the next step is to convert this understanding into code. We must translate the principles of the "Barometric formula" into a format comprehensible to the computer.

Code for Arduino IDE:

```
1  #include <GyverOLED.h>
2  #include <Arduino.h>
3  #include <Wire.h>
4  #include <GyverBME280.h> // library for BMP280
5
6
7  GyverBME280 bme;
8  GyverOLED<SSD1306_128x64, OLED_BUFFER> oled;
9
10 const int BMP280_Address = 0x76; // BMP280 I2C address
11 const float seaLevelTemperature = 288.15; // P0
12 const float lapseRate = 0.0065; // L
13 const float accelerationDueToGravity = 9.80665; // g
14 const float airMolarMass = 0.029; // M
15 const float gasConstant = 8.31447; // R
16
17 float receivedData = 0.0;
```

Fig. 5.9 Constants and Libraries incorporated for BMP280 and the display

Initially, you need to download and link the libraries required for interfacing with our display and pressure with the sensor. Additionally, we declare the variables that play an important role in mathematical calculations based on the formula. It is equally important to establish methods by we'll calculate the required information.

```

float calculateAltitude(float inputPressure) {
    float groundPressure = inputPressure; // P0
    float atmosphericPressure = bme.readPressure();

    if(!atmosphericPressure) {
        return 0.0;
    }

    float altitude = (seaLevelTemperature / lapseRate) * (1.0 - pow((atmosphericPressure / groundPressure), ((gasConstant * lapseRate) / (accelerationDueToGravity * airMolarMass))));

    if(altitude < 0){
        return altitude * (-1);
    }

    return altitude;
}

```

Fig. 5.10 Barometric formula method

The `calculateAltitude()` method computes altitude using the barometric formula, taking into account pressure, current pressure, and ground pressure retrieved from the WinForms application's GUI interface.

There are two main methods in our code: `setup()` and `loop()`. Once you set up the `setup()` function which is responsible for initializing and setting the initial values, the `loop()` function is repeated, as its name suggests, continuing this looping mechanism so that your function can change and execute n 'thing in a dynamic way, and is an important tool for the dynamic management of the Arduino board.

```

void loop() {
  bme.begin(BMP280_Address);

  // Read data from GUI
  if (Serial.available() > 0 && receivedData == 0.0) {
    String s = Serial.readStringUntil('\n');

    receivedData = s.toFloat();
  }

  // Calculate and display data
  if(receivedData > 0) {
    oled.clear();
    oled.home();
    oled.setScale(2);

    oled.print("Altitude\n");
    oled.setCursor(0, 2);
    oled.print("\n");
    float altitude = calculateAltitude(receivedData);
    oled.print(altitude);
    Serial.println(altitude);
    oled.print(" m");

    oled.update();

    delay(1000);
  }
  delay(1000);
}

```

Fig. 5.11 Loop function

Now that we turn our attention to GUI code, we use a platform that makes it easy to create a graphical user interface. This platform offers various controls such as buttons, labels, group boxes and text boxes. After putting all these controls together, I created a detailed GUI in WinForms.





Fig. 5.12 Graphical User Interface

Beneath this interface, we find the underlying code logic. Each control within the interface triggers events to alert you when noteworthy interactions occur. Many of these events are initiated as the user engages with the controls clicking a button or inputting characters into a text field, for instance.

By managing these events, Windows Forms applications actively engage with users and respond to their actions. The fundamental concept behind this code is to establish the capability for the GUI component to interact with Arduino Nano hardware.

GUI transmits ground pressure to Arduino Nano. Arduino then computes altitude using the received data and transmits the calculated data back, which can be visualized on our interface.

```

private void SendDataToArduino()
{
    string groundPressure = pressure_textBox.Text;
    serialPort.WriteLine(groundPressure);
}

private void serialPort_DataReceived(object sender, SerialDataReceivedEventArgs e)
{
    string data = serialPort.ReadExisting();
    var dataFeets = ConvertMetersToFeets(data);
    label_value_meters.Invoke(new Action(() => label_value_meters.Text = data));
    label_value_feets.Invoke(new Action(() => label_value_feets.Text = $"{dataFeets}"));
    altimeter.Invoke(new Action(() =>
    {
        altimeter.Altitude = Convert.ToInt32(dataFeets);
        altimeter.Update();
    }));
}

```

Fig. 5.13 Main Logic of GUI

### 5.6 Analysis and Evaluation of Errors and Accuracy

To verify the accuracy of my altimeter, I chose to assess data at five locations in my hometown. Initially, I recorded measurements using a GPS altimeter and then compared them with readings obtained from my Digital barometric altimeter. The results demonstrated a notable similarity.

Table 5.1: Comparison of two altimeters

Digital Barometric Altimeter	GPS Altimeter
182.1 meters	182.72 meters
180.5 meters	180.2 meters
180.1 meters	179.4 meters
181.4 meters	181.34 meters
181.5 meters	180.57 meters

The article introduces the incorporation of a MEMS pressure sensor in the design of a digital barometric altimeter, showcasing a notable reduction in size and a

substantial increase in accuracy. To enhance precision, a temperature sensor is integrated into the system, implementing dynamic temperature profiling to mitigate temperature-dependent errors commonly found in contemporary standard altimeters with profiled temperature. Experimental results validate that the pressure sensor, based on microelectromechanical systems MEMS, in the digital barometric altimeter delivers superior accuracy in altitude measurement compared to traditional barometric altimeters. The absolute error is within the range of  $\pm 0.2\%$

## CHAPTER 6. ENVIRONMENTAL PROTECTION

### Introduction

Life Cycle Assessment (LCA) is a comprehensive methodology used to evaluate the environmental impact of a product or system throughout its entire life cycle. The life cycle encompasses all stages, from raw material extraction and production to use, maintenance, and eventual disposal or recycling. LCA is a valuable tool for assessing the environmental footprint of products and making informed decisions to minimize their overall impact on the environment.

The primary goal of LCA is to provide a holistic view of the environmental aspects associated with a product or system, considering factors such as resource depletion, energy consumption, emissions to air, water, and soil, and waste generation. This approach allows for a more thorough understanding of the environmental consequences associated with each stage of the life cycle.

### 6.1 Key Components of Life Cycle Assessment

**Goal and Scope Definition:** Clearly define the objectives of the assessment and establish the boundaries of the study, including the system boundaries, functional unit, and the impact categories to be considered.

**Inventory Analysis:** Identify and quantify all inputs (e. g. , raw materials, energy) and outputs (e. g. , emissions, waste) associated with each stage of the life cycle. This step involves creating a detailed inventory of the processes involved.

**Impact Assessment:** Evaluate the potential environmental impacts of the identified inputs and outputs. This step involves assessing the effects on categories such as global warming, acidification, eutrophication, and resource depletion.

**Interpretation:** Analyze the results to draw conclusions and make recommendations based on the identified environmental impacts. Consider trade-offs and identify opportunities for improvement.

#### 6.1.1 Motivation for LCA

##### Product Management / Research & Development

**Comply with Regulations:** Product managers and R&D teams need LCA to ensure that their products adhere to environmental regulations and standards. By understanding the environmental impact throughout the life cycle, they can make informed decisions to meet legal requirements and avoid potential legal issues.

**Develop New Sustainable Products:** LCA is a crucial tool for developing innovative and sustainable products. Product managers and R&D teams can identify

areas for improvement in existing products or create new products with reduced environmental impact. This proactive approach aligns with the growing consumer demand for eco-friendly options and can enhance the company's reputation.

### **Supply Chain Management & Procurement**

**Find Better Suppliers:** LCA helps in evaluating and selecting suppliers based on their environmental performance. Supply chain managers and procurement professionals can use LCA data to assess the sustainability of raw materials and components, ensuring that the entire supply chain contributes to the overall environmental goals of the company.

### **Marketing & Sales:**

**Act on Customer Demand for Sustainability:** In a market where consumers increasingly prioritize sustainable products, marketing and sales teams can leverage LCA data to communicate the environmental benefits of their products. This information can be used in advertising and product labeling to meet the growing demand for eco-friendly choices, thereby enhancing brand image and customer loyalty.

### **Executive Level & Strategic Management**

**Strategic Decision-Making:** Executives and strategic managers use LCA to make informed decisions at a high level. This includes setting overarching sustainability goals, aligning the company's strategy with environmental objectives, and understanding the overall impact of the company's operations. LCA data guides strategic planning for long-term sustainability and corporate responsibility.

## **6.1.2 The Product Life Cycle in LCA: Understanding the 5 Phases**

The product life cycle within the framework of Life Cycle Assessment (LCA) encompasses five crucial stages, spanning from the initial extraction of raw materials to the final disposal. Each phase contributes to the overall environmental impact of a product, and analyzing these stages helps in making informed decisions for sustainable practices. Here are the five steps:

### **Raw Material Extraction**

This phase marks the beginning of the product life cycle, involving the extraction and processing of raw materials required for manufacturing.

Examining the environmental consequences of resource extraction, considering factors such as habitat disruption, land use, and energy consumption.

## **Manufacturing & Processing**

The transformation of raw materials into finished products, involving various manufacturing and processing activities.

Assessing the energy consumption, emissions, and waste generated during the manufacturing process.

## **Transportation**

The movement of products from manufacturing facilities to distribution centers and retailers.

Evaluating the carbon footprint associated with transportation, considering modes of transport, distance, and fuel consumption.

## **Usage and Retail**

The phase when the product is in use by consumers or available for purchase in retail establishments.

Analyzing the energy consumption, emissions, and other environmental effects during the product's use phase, including considerations for maintenance and energy efficiency.

## **Waste Disposal**

The final stage involving the disposal or recycling of the product at the end of its life cycle.

Assessing the impact of waste disposal methods, including landfilling, recycling, or incineration, on the environment.

### **6.1.3 Different Life Cycle Models**

#### **Cradle-to-Grave**

Encompasses the entire life cycle of a product, from the extraction of raw materials (cradle) through production, distribution, use, and disposal (grave).

Provides a holistic view of the environmental impact and allows for comprehensive sustainability assessments.

#### **Cradle-to-Gate**

Focuses on the environmental impact of a product from raw material extraction (cradle) to the point it leaves the manufacturing facility gate.

Useful for manufacturers to understand and optimize the early stages of the life cycle.

#### **Environmental Product Declarations (EPD)**

Offers standardized and transparent information about a product's environmental performance, often based on international standards like ISO 14025.

Aids consumers, businesses, and policymakers in making informed decisions by providing clear and comparable environmental data.

### **Cradle-to-Cradle**

Emphasizes sustainable design principles, aiming to create products that can be fully recycled or repurposed at the end of their life cycle.

Encourages the development of products with minimal environmental impact and promotes circular economy concepts.

### **Gate-to-Gate**

Examines the environmental impact within specific process boundaries, often focusing on a particular stage of the life cycle (e. g. , manufacturing).

Allows for detailed analysis and optimization of specific processes without considering the entire product life cycle.

### **Well-to-Wheel**

Analyzes the environmental impact of fuel production and consumption in the transportation sector, considering the entire supply chain.

Crucial for assessing the sustainability of different energy sources and transportation modes.

### **Economic Input-Output Life Cycle Assessment**

Considers both economic transactions and environmental impacts, providing a comprehensive understanding of a product's life cycle.

Incorporates economic considerations into LCA, allowing decision-makers to assess the dual impact of products on both the environment and the economy.

### **Environmental Impact Assessment**

Evaluates the broader environmental consequences of a product, process, or project, considering various environmental factors beyond LCA.

Offers a comprehensive analysis of environmental effects, including ecological, social, and economic aspects, guiding decision-making in complex scenarios.

## **6.2 Equipment Description: Digital Barometric Altimeter**

The Digital Barometric Altimeter is a sophisticated instrument designed to measure altitude or elevation above a fixed reference point, utilizing advanced pressure sensor technology and microcontroller-based systems.

### **Pressure Sensor**

The pressure sensor is a critical component that detects changes in atmospheric pressure, which is crucial for altitude measurement. Barometric pressure sensors are

commonly employed, converting atmospheric pressure variations into electronic signals.

**Materials:** The pressure sensor is typically constructed using materials compatible with electronic components, such as silicon, ceramic, and metal. The diaphragm, a crucial part of the sensor, might be made of flexible materials like silicon.

### **Microcontroller**

The microcontroller serves as the central processing unit, responsible for receiving data from the pressure sensor, processing it, and providing accurate altitude readings. It acts as the brain of the altimeter, executing the necessary calculations.

**Materials:** Microcontrollers are typically built on semiconductor materials, with silicon being the most common. The integrated circuits (ICs) within the microcontroller are often composed of silicon wafers and metal connections.

### **Printed Circuit Board (PCB)**

The PCB is the physical platform that connects and supports various electronic components. It provides the necessary pathways for electrical signals to travel between the pressure sensor, microcontroller, display, and other peripherals.

**Materials:** PCBs are constructed using a substrate material, often fiberglass-reinforced epoxy. The conductive pathways are made of copper, and solder mask materials are applied for insulation and protection.

### **Display**

The display is the user interface, presenting altitude information in a readable format. Commonly, digital screens, such as LCD or OLED, are used to provide clear and concise altitude readings to the user.

**Materials:** Display technologies vary, but common materials include glass for LCD displays and organic compounds for OLED displays. The frame and casing around the display may be made of plastics, metal alloys, or a combination of materials.

### **Housing/Enclosure**

The housing or enclosure provides physical protection to the internal components, safeguarding them from external factors such as moisture, dust, and impact. The material and design of the housing contribute to the durability and resilience of the altimeter.

**Materials:** The housing is typically constructed from durable and lightweight materials. Common choices include plastics (ABS, polycarbonate), metals (aluminum, titanium), or a combination of materials for enhanced durability.



## **Buttons/Controls**

Input controls, such as buttons or switches, allow users to navigate through different settings, calibrate the device, or access additional features. These controls enhance the user experience and provide flexibility in operation.

**Materials:** Buttons and controls are commonly made of plastics (polyethylene, polypropylene) or elastomers for flexibility and ease of use. The internal components may include metal contacts for conductivity.

## **Connectivity**

Some altimeters may feature connectivity options, such as USB or Bluetooth, enabling data transfer to external devices or facilitating firmware updates. Connectivity expands the functionality and adaptability of the altimeter.

**Materials:** Connectivity ports like USB connectors are often made of metals like nickel-plated brass or aluminum. Wireless connectivity components may include antennas made of conductive materials.

## **Memory**

In certain models, onboard memory may be included for storing historical altitude data or user preferences. This feature can be valuable for users who want to track altitude changes over time.

**Materials:** The memory components on the PCB are typically silicon-based integrated circuits. The casing for memory modules may be made of plastic or metal for protection.

## **Altitude Reference System**

Some altimeters may incorporate an altitude reference system, enabling users to set a specific reference point or adjust for regional variations in atmospheric pressure, enhancing the accuracy of altitude measurements.

**Materials:** Components of the altitude reference system, such as sensors or adjustment mechanisms, may be constructed using materials like silicon, metals, and durable polymers.

## **6.3 Environmental Impact at Each Life Cycle Stage**

### **1. Raw Material Extraction**

The extraction of raw materials, such as silicon for sensors, metals for circuitry, and plastics for casings, involves energy-intensive processes. Mining activities, particularly for metals, can lead to habitat disruption, soil erosion, and water pollution. Sustainable sourcing practices and material recycling can mitigate these impacts.

## 2. Manufacturing & Processing

The manufacturing stage contributes to greenhouse gas emissions, energy consumption, and waste generation. The production of electronic components, assembly processes, and chemical usage can have significant environmental effects. Implementing energy-efficient manufacturing practices and adopting cleaner production technologies can help reduce these impacts.

## 3. Transportation

Transportation involves the movement of raw materials, components, and the final product. Fuel consumption during shipping or transit contributes to carbon emissions and air pollution. Optimizing transportation routes, using eco-friendly transport modes, and considering regional sourcing can minimize these environmental effects.

## 4. Usage and Retail

The usage phase primarily involves energy consumption, as the altimeter requires power for sensor readings and display operation. Energy-efficient design, low-power modes, and user education on responsible energy use can mitigate the impact during this stage. Additionally, the durability of the device influences the frequency of replacements and, consequently, electronic waste generation.

## 5. Waste Disposal

Disposal or recycling of electronic devices poses environmental challenges. Improper disposal in landfills can lead to hazardous material leaching, while recycling processes may involve energy-intensive procedures. Implementing proper e-waste recycling programs, encouraging responsible disposal practices, and designing devices for easier recycling can help address these concerns.

The Digital Barometric Altimeter, like many electronic devices, exhibits environmental impacts at various life cycle stages. Sustainable practices, such as materials recycling, energy efficiency, and responsible disposal, can mitigate these effects. Continuous efforts in eco-design, using environmentally friendly materials, and adopting circular economy principles contribute to reducing the overall environmental footprint of the altimeter. Additionally, educating users about proper usage and disposal practices further enhances the sustainability of the product throughout its life cycle.

## **6.4 Comparison with Other Products**

Altimeters are indispensable instruments used for determining altitude, a critical parameter in various fields, including aviation, outdoor activities, and industrial applications. Different altimeter technologies have evolved to meet

specific needs and challenges associated with altitude measurement. In this comparison, we'll explore three prominent types of altimeters: digital barometric altimeters, analog barometric altimeters, and radar altimeters. Each technology employs distinct principles and features, catering to diverse requirements and environments.

By understanding the strengths and limitations of each altimeter type, users can make informed decisions based on their specific applications and operational conditions.

### **Digital Barometric Altimeter**

Measures altitude based on changes in atmospheric pressure. A pressure sensor detects variations in atmospheric pressure as the user moves in altitude and converts this information into altitude readings.

Digital barometric altimeters present altitude information digitally on a screen or display, often with additional features such as data logging, trend analysis, and other advanced functionalities. It can provide accurate altitude readings in stable weather conditions.

### **Analog Barometric Altimeter**

Similar to digital barometric altimeters, analog barometric altimeters also measure altitude using changes in atmospheric pressure. However, they display the information using a traditional analog dial and needle. The altitude information is represented by a needle moving along a dial, providing a visual representation of the altitude.

Analog barometric altimeters can be accurate, but their precision may be lower compared to digital versions. They are also influenced by weather conditions.

### **Radar Altimeter**

Radar altimeters use radio waves to determine altitude. They send a signal towards the ground and measure the time it takes for the signal to reflect back. This provides a direct measurement of the distance between the aircraft and the ground, from which altitude is derived.

Radar altimeters typically have a digital display, providing real-time altitude information to the pilot. They are highly accurate at low altitudes, making them essential for aircraft during takeoff and landing. However, they may not be as accurate at higher altitudes.

## **6.4.1 Differences**

### **Measurement Method**

Digital barometric altimeters measure altitude based on atmospheric pressure changes. Analog barometric altimeters use the same principle but present information with a traditional analog dial. Radar altimeters measure altitude directly using radio waves.

### **Display**

Digital barometric altimeters present information digitally on a screen. Analog barometric altimeters use a dial and needle for display. Radar altimeters typically have a digital display.

### **Application**

Digital and analog barometric altimeters are commonly used in aviation, outdoor activities, and various industrial applications. Radar altimeters are primarily used in aviation for low-altitude operations, such as during takeoff and landing.

### **Altitude Range**

Digital and analog barometric altimeters are suitable for a wide range of altitudes. Radar altimeters are particularly accurate at low altitudes and may not be as precise at higher altitudes.

## **Environmental Considerations**

All altimeter technologies necessitate proper end-of-life disposal to mitigate environmental impact. Recycling and responsible disposal practices can significantly reduce the ecological footprint associated with these instruments.

The energy efficiency of altimeters, especially in their operational phase, contributes to their overall environmental friendliness. Choosing altimeters with energy-efficient features aligns with sustainable practices.

## **6.5 Recommendations for Minimizing Environmental Impact**

In order to mitigate the environmental impact of the Digital Barometric Altimeter across its life cycle, there are recommendations that should be taken into account

### **1. Sustainable Materials Selection**

Prioritize the use of environmentally friendly materials in the manufacturing process, opting for recycled or recyclable materials where feasible.

Explore alternatives to traditional materials that have a lower environmental footprint.

## 2. Energy Efficiency Optimization

Implement energy-efficient design features in the microcontroller and sensor systems to minimize power consumption during the usage phase.

Explore renewable energy sources for powering the altimeter or consider energy harvesting technologies.

## 3. Eco-Design Principles

Embrace eco-design principles by focusing on product longevity, repairability, and modular design to extend the lifespan of the altimeter.

Design components with standardized connectors to facilitate easier repair and upgrades.

## 4. End-of-Life Management

Establish a take-back program to facilitate proper disposal or recycling of old devices, promoting responsible end-of-life management.

Provide clear instructions to users on environmentally friendly disposal practices.

## 5. Product Life Extension

Offer firmware updates to enhance functionality and address potential issues, prolonging the useful life of the altimeter.

Encourage users to maximize the lifespan of the product through proper maintenance and care.

## 6. Environmental Certification

Pursue environmental certifications such as EPEAT or other relevant standards to demonstrate a commitment to sustainability.

Clearly communicate the altimeter's compliance with environmental regulations and standards to users.

## 7. User Education and Awareness

Develop educational materials for users on sustainable practices, including energy-efficient usage, responsible disposal, and the environmental benefits of the altimeter.

Encourage users to participate in eco-friendly behaviors, such as reducing energy consumption and participating in e-waste recycling programs.

## 8. Collaborate with Suppliers

Engage with suppliers to ensure responsible sourcing of raw materials and promote sustainable practices within the supply chain.

Collaborate with suppliers to explore opportunities for reducing the environmental impact of manufacturing processes.

Implementing these recommendations will contribute to a more environmentally conscious approach to the Digital Barometric Altimeter's life cycle, aligning with broader sustainability goals and fostering responsible consumption practices.

## **6.6 Conclusions to Chapter**

This life cycle assessment (LCA) explores the environmental impact and sustainability considerations associated with the Digital Barometric Altimeter. Through a comprehensive analysis of its life cycle stages, from raw material extraction to end-of-life disposal, key insights have been gained.

The altimeter incorporates materials such as silicon, metals, and plastics, prompting a focus on sustainable materials selection and manufacturing practices. Its energy-efficient design, driven by a microcontroller and pressure sensor, contributes to reduced energy consumption during use. Responsible end-of-life management, including recycling programs and proper disposal practices, emerges as a critical factor in mitigating electronic waste's environmental impact.

Comparisons with alternative altimeters underscore the importance of factors such as energy efficiency, materials selection, and end-of-life considerations in determining overall sustainability. Recommendations for improvement encompass sustainable materials selection, energy efficiency optimization, eco-design principles, and end-of-life management strategies.

Establishing a culture of continuous improvement, collaboration with suppliers, and community engagement are identified as vital components of ongoing sustainability efforts. User education on sustainable practices, product longevity, and responsible disposal adds another layer to fostering an environmentally conscious user base.

Pursuing environmental certifications and adhering to relevant standards not only demonstrates commitment but also aligns the Digital Barometric Altimeter with broader sustainability goals. By adopting a holistic approach to sustainability and integrating recommendations into its life cycle, the altimeter stands as a potential benchmark for environmentally conscious design and usage in altitude measurement devices.

## **CHAPTER 7 OCCUPATIONAL SAFETY AND HEALTH**

### **7.1 Organization of the Engineer or Developer Workplace**

In the context of developing a Digital Barometric Altimeter, meticulous attention to the organization of the engineer-developer's workplace is paramount. This involves not only creating a conducive environment for productive work but also ensuring the safety and well-being of the personnel involved. The expansion of this chapter includes more detailed considerations:

#### **Equipment Placement**

Identify specific tools and devices crucial for Digital Barometric Altimeter development, such as programming devices, testing instruments, and prototype components.

Arrange equipment based on frequency of use, ensuring that commonly accessed tools are easily reachable to streamline workflow.

Consider implementing cable management solutions to reduce clutter and minimize the risk of tripping hazards.

#### **Workspace Area**

Assess the spatial requirements for tasks related to Digital Barometric Altimeter development, including assembly, testing, and programming.

Allocate sufficient space for comfortable movement, especially in areas where physical testing and calibration of the device may take place.

Ensure that the workspace allows for flexibility to accommodate changes in project requirements.

#### **Workstation Ergonomics**

Delve deeper into ergonomic principles, addressing factors such as the height and positioning of work surfaces, chair ergonomics, and screen placement.

Consider the implementation of adjustable furniture to accommodate diverse preferences and body types among the engineering team.

Encourage breaks and exercises to prevent prolonged periods of sitting and reduce the risk of musculoskeletal issues

#### **Safety Protocols**

Develop comprehensive safety protocols specific to Digital Barometric Altimeter development, considering potential hazards associated with electronic components and testing procedures.

Provide clear signage for emergency exits and locations of fire extinguishers, first aid kits, and other safety equipment.

Establish regular safety training sessions to ensure that all team members are familiar with emergency procedures.

### **Digital Security Measures**

Elaborate on the digital security measures, including the use of encryption tools, secure access controls, and regular cybersecurity training for the engineering team.

Implement measures to secure intellectual property related to the Digital Barometric Altimeter, such as access restrictions and encrypted storage for sensitive data.

### **Document Organization**

Specify the types of documents involved in Digital Barometric Altimeter development, including schematics, manuals, and safety guidelines.

Propose a systematic filing system, whether digital or physical, to ensure easy retrieval and organization of essential project-related documents.

### **Collaboration Spaces**

Explore digital tools for collaborative project management, communication, and version control, facilitating seamless cooperation among team members.

Designate physical spaces for team meetings, brainstorming sessions, and collaborative work, promoting effective communication and idea exchange.

By addressing these nuanced aspects of workplace organization, the engineer or developer's environment becomes not only efficient but also optimized for safety and collaboration in the intricate process of Digital Barometric Altimeter development.

## **7.2 Analysis of Hazardous Factors in the Workplace**

In the realm of developing a Digital Barometric Altimeter, a comprehensive analysis of potential hazardous factors in the workplace is imperative for ensuring the well-being of the engineering team. This section delves into various aspects, including electrical safety, noise exposure, handling of harmful substances, adequacy of lighting, microclimatic conditions, and other relevant considerations.

### **Electrical Safety**

Conduct a thorough assessment of all electrical equipment involved in Digital Barometric Altimeter development, identifying potential risks and ensuring compliance with safety standards.



Implement measures such as proper grounding, insulation, and regular equipment checks to minimize the risk of electrical hazards.

Provide training on safe practices for handling electrical components and responding to emergencies like short circuits.

#### Noise Exposure

Identify sources of noise within the workplace, particularly those associated with testing equipment or machinery used in Digital Barometric Altimeter development.

Measure and assess the level of noise exposure to determine the need for personal protective equipment (PPE) such as earplugs or earmuffs.

Consider engineering controls, like soundproofing or isolating noisy equipment, to mitigate overall workplace noise.

#### Handling Harmful Substances

Identify and assess any potentially harmful substances involved in the development process, such as chemicals used in manufacturing or testing.

Implement proper storage, handling, and disposal procedures for these substances.

Provide appropriate personal protective equipment and ensure that all team members are trained in its use.

#### Adequacy of Lighting

Evaluate the lighting conditions in areas where engineering tasks related to Digital Barometric Altimeter development occur.

Ensure that lighting is adequate for precision work and that there is minimal glare on computer screens.

Consider natural lighting options and adjustable lighting to accommodate varying tasks and preferences.

#### Microclimatic Conditions

Monitor and control the temperature and humidity levels in the workspace, especially if the development involves delicate electronic components.

Implement measures such as air conditioning, ventilation, or heating to maintain a comfortable and stable microclimate.

Provide guidance on dressing appropriately for the prevailing conditions.

## Vibration

Identify any machinery or equipment that generates vibrations during the development process.

Assess the potential impact of vibrations on the well-being of the engineering team, especially if prolonged exposure is likely.

Introduce vibration-damping materials, anti-vibration mounts, or consider redesigning workstations to minimize the effects of vibration.

## Radiation

Determine if there are sources of radiation within the workplace, such as electronic components emitting electromagnetic radiation.

Implement shielding measures or relocation of sources to minimize exposure.

Provide radiation safety training and ensure that personnel are aware of appropriate protective measures.

## Ergonomic Challenges

Identify ergonomic challenges that may arise during prolonged development tasks.

Evaluate workstations for comfort, considering adjustable chairs, keyboards, and monitors.

Encourage regular breaks and stretching exercises to prevent musculoskeletal issues associated with prolonged sitting or repetitive tasks.

## Chemical Exposure

Examine any chemicals used in the development process, including cleaning agents, adhesives, or solvents.

Implement measures to reduce exposure, such as using less hazardous substances or providing adequate ventilation.

Ensure the availability and proper use of personal protective equipment, including gloves and masks.

By considering these supplementary factors, the analysis of workplace hazards attains a higher degree of comprehensiveness, thereby enhancing safety measures for the intricate and multifaceted process involved in the development of Digital Barometric Altimeters.

### **7.3 Detailed Analysis of the Electrical Safety Factor in the Workplace**

In the realm of developing Digital Barometric Altimeters, ensuring the safety of electrical systems is paramount. This chapter delves into a thorough examination of electrical safety considerations, covering key components and practices to mitigate potential hazards. From the overview of the electrical system to personnel training and emergency response plans, this comprehensive analysis aims to fortify the workplace against electrical risks associated with Digital Barometric Altimeter development.

When utilizing a digital altimeter for measurements outdoors or in conditions with an elevated risk of electric shock, it is imperative to adhere to electrical safety guidelines. Ensure the use of digital altimeters compliant with relevant safety standards, such as IEC 60364 for low-voltage electrical installations. Emphasize the importance of personal protective equipment, especially in environments with heightened electric shock hazards.

For portable electrical energy receivers (electrotechnical devices) intended for connection to a power source, it is essential that they adhere to standards, such as GOST 12.2.007.0-75. These standards should specify the inclusion of a cable with a grounding wire and a plug connection incorporating a grounding contact. This design should facilitate the pre-engagement of the grounding contact during connection and its disengagement upon disconnection, ensuring a safe operational environment.

The foundation of electrical safety lies in a comprehensive understanding of the electrical system. This involves a detailed examination of power sources, distribution panels, and connections. The identification of critical points susceptible to potential electrical hazards is crucial for preemptive risk management.

A comprehensive risk assessment is conducted to identify and address potential issues such as short circuits, overloads, and electric shock. This step ensures that the development process is well-prepared to handle electrical challenges and minimizes the risk of accidents or malfunctions.

Adherence to relevant electrical safety standards and regulations is non-negotiable. Regular reviews and updates of practices are essential to ensure alignment with industry standards, guaranteeing that the development process remains in compliance with the latest safety protocols.

Establishing a routine inspection schedule for all electrical equipment is fundamental. This includes the implementation of preventive maintenance measures to detect and address issues before they escalate, thereby minimizing the risk of electrical failures.

A specialized training program on electrical safety is developed for individuals involved in Digital Barometric Altimeter development. Proficiency training equips personnel with the knowledge to recognize and respond effectively to electrical hazards, fostering a safer working environment.

Formulating a detailed emergency response plan specific to electrical incidents is imperative. This plan includes clear definitions of roles, responsibilities, and evacuation procedures to ensure a swift and organized response in case of unforeseen electrical emergencies.

Strict isolation procedures are implemented for equipment maintenance and repair, minimizing the risk of accidents during these critical activities. Necessary tools and equipment are provided to facilitate safe isolation practices.

Proper grounding and bonding practices are emphasized to prevent electric shock. Regular inspections of grounding systems are carried out to ensure their effectiveness, mitigating potential hazards associated with electrical grounding.

Specification of appropriate Personal Protective Equipment for tasks involving electrical components is a crucial aspect of ensuring personnel safety. Consistent enforcement of PPE usage and regular checks for effectiveness further enhance the overall safety measures.

In conclusion, this comprehensive electrical safety analysis serves as a robust framework to safeguard against potential hazards during the development of altimeters.

## **7.4 Fire Safety**

In the intricate landscape of altimeter development, where innovation and precision intertwine, the spotlight turns to fire safety as a pivotal player.

The journey begins with a comprehensive assessment of potential fire risks unique to Digital Barometric Altimeter development. This involves identifying areas with an elevated risk, considering the presence of electronic components, power sources, and materials susceptible to combustion. By understanding these risks, proactive measures can be implemented to minimize the likelihood of fire incidents.

A key element in the arsenal against fire threats is the implementation of state-of-the-art fire suppression systems tailored to the nuances of the development environment. This includes strategically positioning fire extinguishers, sprinkler systems, or other suppression mechanisms to ensure a rapid and effective response to emerging fire threats.

Preparedness is paramount, and this involves formulating and communicating clear emergency evacuation procedures. Specifics, such as exit routes, assembly points, and the use of emergency exits, are detailed to ensure a swift and organized

response in the event of a fire. Regular drills further familiarize the engineering team with evacuation protocols, enhancing overall readiness.

Readily accessible firefighting equipment, including fire extinguishers, fire blankets, and first aid kits, are strategically placed throughout the workspace. Ensuring that the engineering team is proficient in the use of firefighting equipment through regular training sessions enhances the overall capability to respond effectively to fire incidents.

Fire safety is not a standalone consideration but is seamlessly embedded into daily work practices. Emphasis is placed on the importance of vigilance and proactive measures. Protocols for the safe storage and handling of materials prone to combustion are established, minimizing fire risks within the developmental landscape.

Fostering collaboration with local emergency services is essential. Providing them with an understanding of the unique challenges posed by Digital Barometric Altimeter development and establishing communication channels and protocols for coordinating emergency responses with external firefighting and rescue teams enhance overall emergency preparedness.

The arsenal against fire hazards includes advanced fire monitoring and detection systems. Integrating smoke detectors, heat sensors, and automated alert systems provides early warnings in the event of potential fire outbreaks, enhancing situational awareness and response times.

To ensure ongoing efficacy, fire safety protocols are subjected to regular reviews and updates to align with industry standards and evolving best practices. Post-incident analyses are conducted to identify areas for improvement, and corrective measures are implemented for enhanced resilience.

By weaving these elements into the narrative of Digital Barometric Altimeter development, fire safety becomes an integral and proactive component of the workspace.

## **7.5 Organizational and Technical Measures to Combat Harmful and Hazardous Factors**

Development of altimeters, addressing harmful and hazardous factors requires a strategic blend of organizational and technical measures. This section unveils a multifaceted approach to mitigate risks and create a workspace optimized for safety and efficiency.

## Organizational Measures

### **Workplace Ergonomics**

Tailor workstations to ergonomic principles, ensuring comfort and preventing musculoskeletal issues.

Promote regular breaks and exercises to alleviate the strain associated with prolonged periods of work.

### **Safety Protocols**

Establish and enforce comprehensive safety protocols, encompassing the handling of equipment, emergency procedures, and adherence to industry best practices.

Regularly conduct safety drills to familiarize the engineering team with emergency protocols.

### **Collaborative Spaces**

Designate areas for collaboration, fostering effective communication among team members.

Leverage digital tools for project management, enhancing collaboration and coordination within the team.

## Technical Measures

### **Digital Security Measures**

Implement robust digital security measures to safeguard sensitive data related to Digital Barometric Altimeter development.

Enforce access controls, encryption protocols, and regular cybersecurity training to fortify the digital perimeter.

### **Fire Safety**

Conduct a thorough assessment of fire risks within the workspace, especially considering the presence of electronic components.

Install fire suppression systems and provide adequate firefighting equipment in accessible locations.

### **Ventilation and Air Quality**

Evaluate ventilation systems to ensure optimal air quality, especially when working with materials that may emit harmful substances.

Implement measures to control air pollutants and maintain a healthy indoor environment.

## **Temperature Control**

Monitor and regulate microclimatic conditions to ensure the comfort and well-being of the engineering team.

Implement heating, ventilation, and air conditioning (HVAC) systems to maintain an optimal working temperature.

## **Noise Reduction Strategies**

Identify sources of noise within the development environment and implement measures to minimize exposure.

Introduce noise reduction technologies or utilize soundproofing materials to create a quieter workspace.

## **7.6 Conclusions to Chapter**

After a meticulous examination of the working conditions of engineers engaged in the installation of digital barometric altimeters, it is evident that the effectiveness and safety of their work are closely linked to an appropriate level of safety and organizational-technical preparedness. The analysis highlights certain potential threats, such as the correct installation and operation of digital barometric altimeters, time constraints, and the possibility of stressful situations.

Technological innovations can also be a key factor in improving working conditions. The use of physiological monitoring and the introduction of ergonomic equipment can positively influence job comfort and reduce risks associated with physical strain.

## **CONCLUSION**

In conclusion, the integration of a barometric altimeter within GPS systems, weather stations, and industrial applications presents a versatile solution for height determination. This compact and cost-effective technology offers remarkable accuracy, making it a valuable tool across various domains. The digital barometric altimeter's versatility extends to applications in small unmanned aerial vehicles (UAVs) and among skydivers, showcasing its adaptability and effectiveness in diverse scenarios. Its small form factor, affordability, and precise altitude measurement capabilities position it as a reliable choice for a wide range of uses in both recreational and professional contexts.

Moreover, the digital barometric altimeter stands out as a safe and ecological option. Its design prioritizes environmental sustainability and user safety, aligning with modern preferences for technology that minimizes ecological impact. This dual focus on accuracy and eco-friendliness enhances the overall appeal and practicality of the digital barometric altimeter in today's technological landscape.



## REFERENCES

- 1) Wang, Y., Zhang, L., Li, W., & Wang, J. (2019). Design and implementation of a digital barometric altimeter. *International Journal of Advanced Robotic Systems*, 16(4), 1729881419848514.
- 2) Maluf, N. I., & Williams, K. R. (2003). *An introduction to microelectromechanical systems engineering*. Artech House.
- 3) Young, L., & Young, W. (2019). Barometric altimeter system and method. U.S. Patent No. 10,344,771.
- 4) Li, Y., Fu, Y., Zhang, Y., & Yu, J. (2018). MEMS pressure sensors for high temperature applications: A review. *Sensors*, 18(7), 2137.
- 5) Guerreiro, F., Silvestre, C., & Oliveira, P. (2018). Unmanned aerial vehicle altitude estimation using a barometric sensor and a monocular camera. *Aerospace Science and Technology*, 76, 449-458.
- 6) Liao, W. H., Lin, C. S., & Hsu, J. Y. (2016). A high-precision digital altimeter for unmanned aerial vehicles. *Journal of Aerospace Science and Technology*, 48, 320-328
- 7) Lin, Y., Cheng, Z., Cheng, Y., & Cai, Q. (2019). A review on MEMS sensors for environmental monitoring. *Sensors*, 19(8), 1901.