

UDC 121.548.5(045)

¹V. M. Sineglazov,
²K. I. Kaleniuk**AUTOMATED DESIGNING OF DRIVER FOR LIGHT-EMITTING-DIODE LAMPS**

Aviation Computer-Integrated Complexes Department, National Aviation University, Kiev, Ukraine

E-mails: ¹svm@nau.edu.ua, ²kik1092@mail.ru**Abstract**—The article describes algorithm for designing of led driver based on the use of computer-aided design systems.**Index Terms**—Design problem; computer-aided system; light-emitted diode systems; calculation of light characteristics; radiator projection; calculation of transformer; optimization.

I. INTRODUCTION

The intrusion of innovative led lighting is one of the important issues of the power industry today. Light-emitting-diode (LED) lamps (led lamps), unlike incandescent and fluorescent lamps are directional light sources and relatively their efficiency in the application is higher, than in the traditional sources of light, in which 40–50 % of the total light output is lost. Positive characteristics of led lamps in comparison with other light sources are: low power consumption, safety, environmental friendliness, protracted term of exploitation (the term of service of the led diode can reach at 50,000 hours).

The disadvantages of such devices should be primarily attributed a high price and also high sensitiveness of light-emitting diodes to quality of power supply. The current of light-emitting diode increases stronger, than supplied to him voltage. According, even small changes in voltage can cause large changes in current, so that the led goes down. To connect the led light to voltage source, such as a power source or accumulator, and it is not damaged at the same time, need to control power consumption, so that the light-emitting diodes can safety use it. This function performs a power supply for LED driver. This function performs a power supply for light-emitting diodes is a driver. Light-emitting driver protects the LEDs from the normal voltage fluctuations and also surges and voltage spikes. On the basic descriptions, it should provide the necessary level of output voltage and current, to have a minimum level of ripple, good heat dissipation and to provide reliable operation over a long time. Moreover, the power supply (PS) should have the minimum possible size and weight. Structural scheme can be represented in the Fig. 1.

For led diver capacity is an array of LEDs. Input filter is designed to prevent the ingress of impulse noise in the network.

Power switches are provide the supply of high voltage pulses to the primary winding of high-frequency transformer.

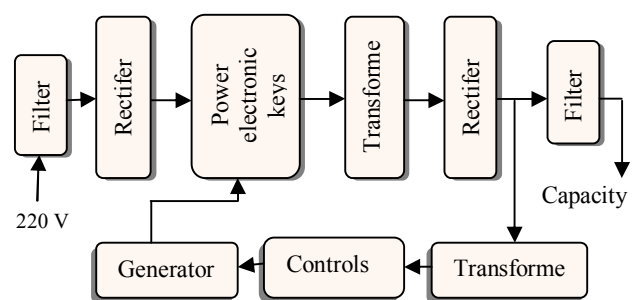

Fig. 1. Structural scheme of a pulse led driver from the network

The frequency and value of pulses are controlled by generator. The feature of the output of the rectifier is not used normal power diodes and the high speed diodes of Schottky, due to the high frequency straighten voltage. Output filter smoothes the output voltage ripple. The voltage of feedback compared with the reference voltage, and then manages the generator. Also present galvanic isolation in the feedback circuit, which is necessary to provide isolation of the output voltage with the network. The presented blocks are basic components influencing on the influencing of the coefficient of performance (CP) power supply, and also on the effectiveness of the lighting device, durability and reliability.

II. THE STATEMENT OF THE PROBLEM

Due to the fact that the process of designing driver for led lighting device is enough multistage, and also have many of factors influencing on its effectiveness appropriate use of automated design systems (CAD). With the help of such systems it is necessary to solve a number of tasks such as:

- electrotechnical calculation of electronic components of the driver;
- a choice of complex technical equipments;
- development of printed circuit boards;

– manufacturing simulation model of power supply;

– creation of documentation.

The solution of the above tasks by means of CAD-system will allow to develop an effective driver for the type of lamp, to reduce time of work

performance and get the visualization of model of device.

III. STRUCTURAL SCHEME OF CAD-SYSTEM

Taking into account the tasks, structural diagram for a system of automated design of power supply, which is presented in Fig. 2.

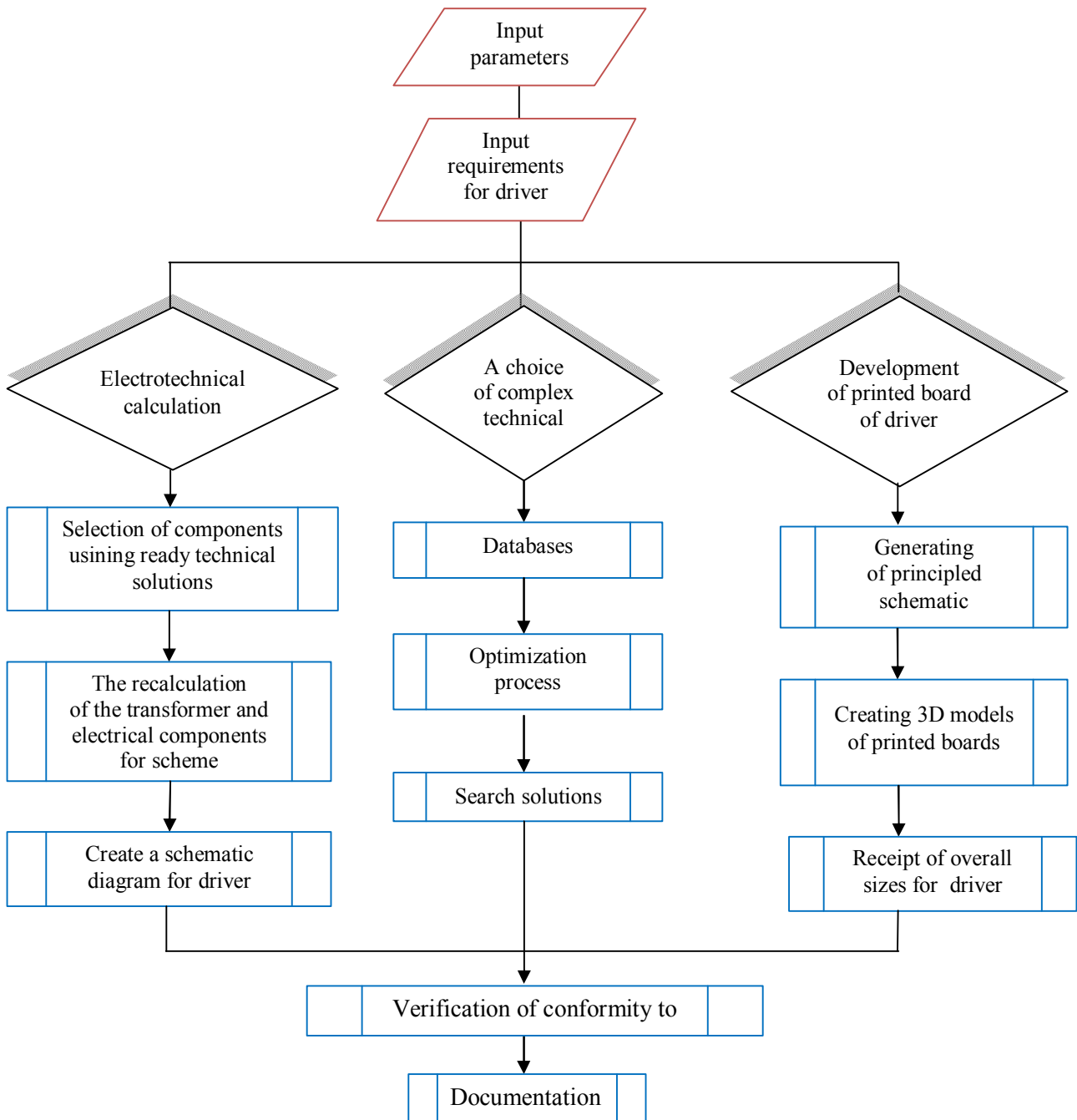

Fig. 2. Structural scheme of CAD-system for led driver

For solving the problem of development of the printed board and schematic diagrams of the driver is most appropriate to use a ready-made software packages that will accelerate the process of

development of the instrument. Such as Altium Designer, KiCad, Proteus or P-CAD. Structural scheme of the block “design printed board of driver” (see Fig. 2) can be represented as follows (Fig. 3).

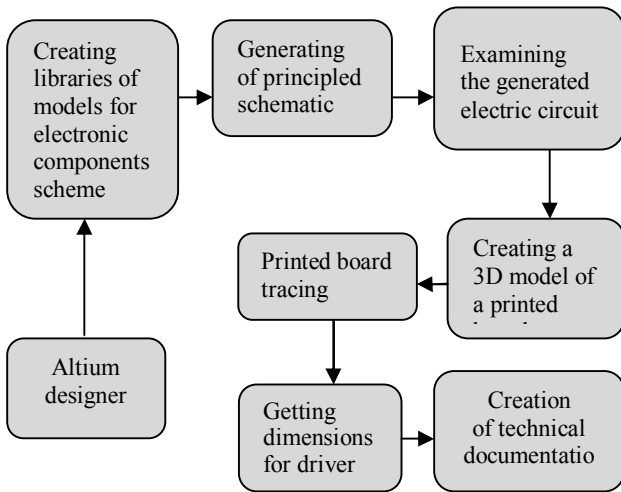

Fig. 3. Structural scheme of the block “design printed board of driver” using a CAD-system

The selected program complex allows in interactive mode, when inconsistencies are found, regulations or the requirements set, to make amendments in the scheme or the Board model. Whereupon made in automatic mode, the documentation on the designed device.

IV. SELECTION OF OPTIMAL ELEMENTS OF POWER SUPPLY

Selection of the element base, the design of les driver with the help of the proposed CAD-system, is performed using multicriterial optimization. The ultimate goal of optimization is to find the best or optimal decisions with a few criteria of selection. To optimize necessary: a mathematical model of the object, the target function and optimization algorithm (see Fig. 4). The objective function formalizes the requirements to the object (maximization gain, increased reliability, lower cost, profit maximization, and so on).

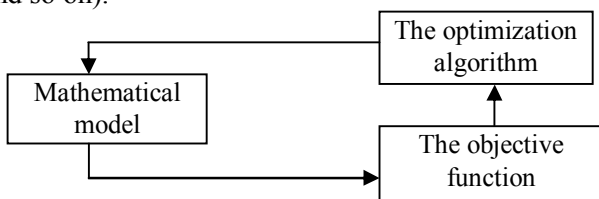

Fig. 4. The algorithm for multicriterial optimization

The decision task is to choose among a set of possible solutions (called also options, plans and so on) of this decision, which would be, in a sense, the best or, as they say, the best.

Mathematical models include the following elements:

- initial data;
- desired variables;
- dependence.

When considering private tasks for the user the most convenient would be to program multi-criteria optimization, parameter estimation, in which you want to set only the value of the coefficients and choose the method of multi-criteria optimization with the opportunity to see the Pareto. The software system must meet the requirements of reliability, security, compatibility and user-friendly interface. The choice of one of the decisions of the Pareto set a difficult task, so often an important feature of the system is the decision maker. As for the solutions of an effective variety of methods, the program must support multiple methods of multi-criteria optimization.

IV. DESIGNING OF LED DRIVER

Solving the tasks of calculation and selection of hardware components for the design of the instrument, in accordance with structural scheme CAPR Fig. 2, the next step in the system is to develop an electrical schematic and printed circuit board. To do this in CAD-system was integrated software complex Altium Designer (algorithm of block Altium Designer presented in Fig. 4). In order to develop the concept in an integrated software package, you should build a model of electronic components, obtained in the calculations. The widget appears in the program in three-dimensional graphics and structural form, as shown in Fig. 5.

After the end of the build process item, it is saved in the database of the program, where it can be used for other technical solutions.

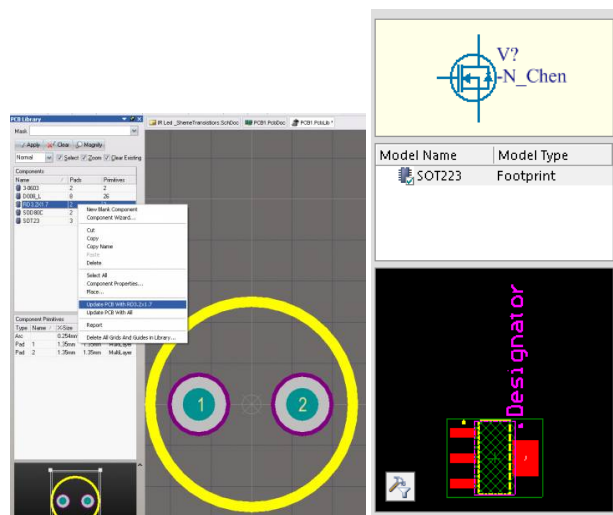

Fig. 5. Control Panel building a model electronic component and library designed element

Then you schematic development (Fig. 6), designed driver. In the next step, check the accuracy of the scheme and errors.

Only after that all the components are transferred to another window to start the PCB layout.

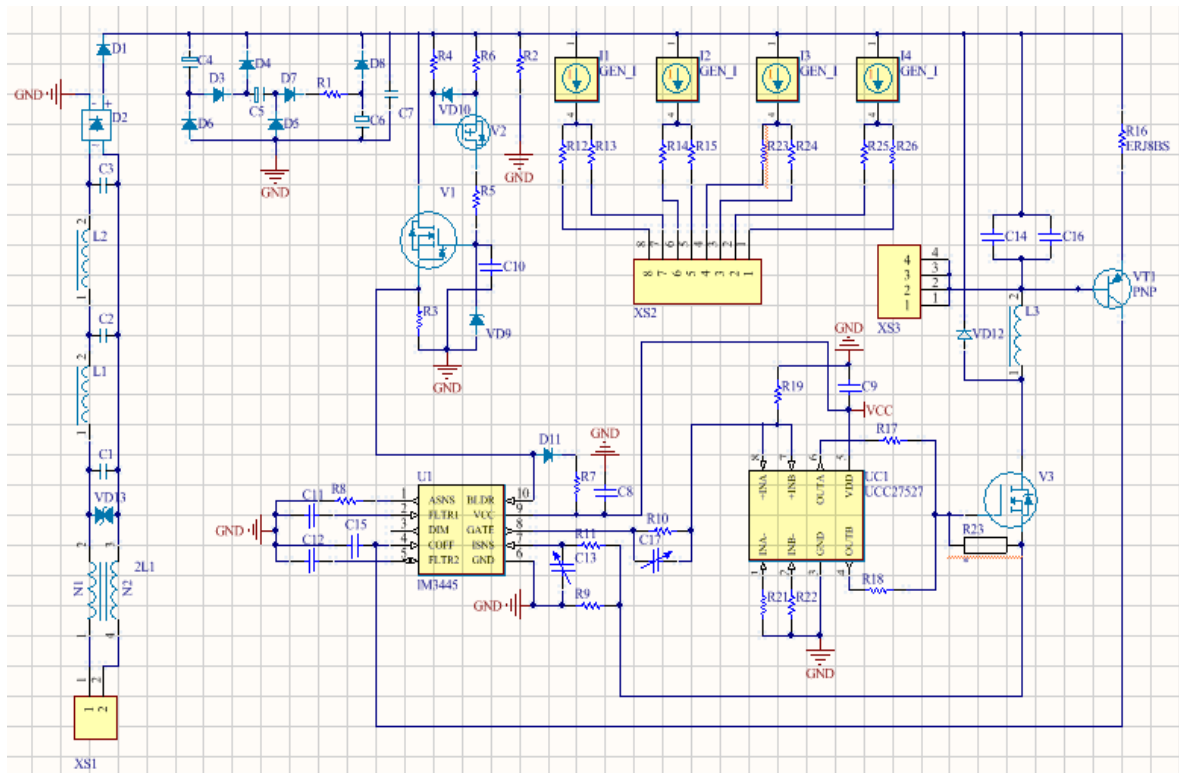

Fig. 6. Schematic diagram of entrepreneurs in the environment Altium Designer

Because you need to minimize the size of the Board, it created bilateral and need to properly deploy its elements. To simplify the process is also

convenient to use SAPR. It also has the ability to work with layers and to see how better to dilute the components on the Board (Fig. 7).

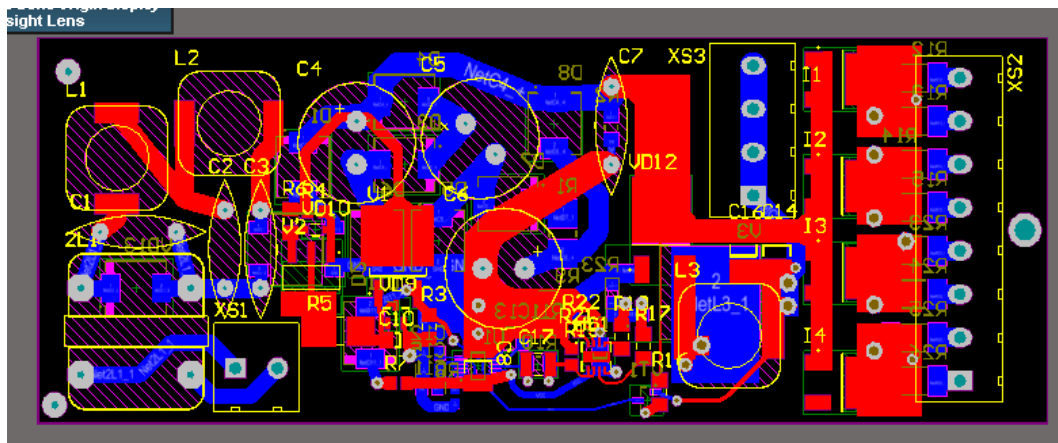

Fig. 7. The location of the components on the printed board and tracing

The final results of the design in the system are represented not only in the two-dimensional, as well as in the 3D view with the indication of the overall parameters parted (Fig. 8).

Doing all of the above steps, you create the documentation on the designed power supply which includes:

- a list of optimal elements of IP;
- schematic diagram of IP;
- tracing circuit Board;
- dimensions of the Board and its 3D visualization.

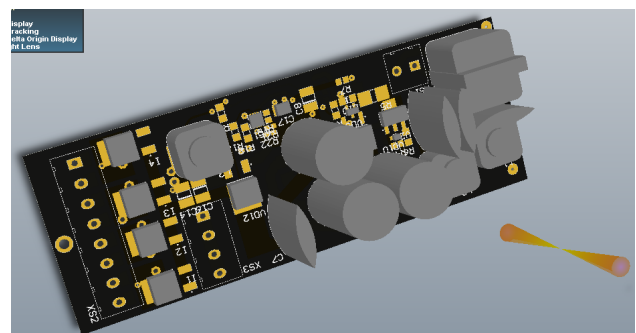

Fig. 8. 3D-model designed printed board

V. CONCLUSION

Substantiated the necessity of computer-aided design developing for the led driver that will allow to reduce time of designing and to improve its quality, to perform optimal element base with solving the problem of multicriterial optimization. As well integrating in the system software for the simulation of the PCB, the opportunity to evaluate the results, to determine the dimensions of driver and its design.

The structure of CAD-system, which has 2 calculation module and integrated software package Altium Designer includes the solution of such problems: the calculation of the electrical characteristics; determination of the elemental base of the driver; the development of the PCB and finding dimensions of the device; modeling of the device;

documentation; the presence of some of the design decisions for the task.

The developed CAD-system, one of the main advantages of which was ensuring maximum efficiency of work with this program into practice through ease of use and maximum visibility of the results.

REFERENCES

- [1] Biriukov, E. "Element base and methods of its application to control problems of power for LEDs." *Components and technologies* N 11. 2006.
- [2] Selivanov, M. "LED driver." *Components and technologies*. N 2. 2008.
- [3] Podinovsky, V. V.; Nogin, V. D. Pareto – optimal solutions for multiobjective problems. 1982.

Received 03 march 2014

Sineglazov Viktor. Doctor of Engineering. Professor.

Aviation Computer-Integrated Complexes Department, National Aviation University, Kyiv, Ukraine.

Education: Kyiv Polytechnic Institute, Kyiv, Ukraine (1973).

Research area: Air Navigation, Air Traffic Control, Identification of Complex Systems, Wind/Solar power plant.

Publications: 460.

E-mail: svm@nau.edu.ua

Kaleniuk Kristina. Student.

Aviation Computer-Integrated Complexes Department, National Aviation University, Kyiv, Ukraine.

Education: National Aviation University, Kyiv, Ukraine.

Research area: energetic, computer-aided design.

Publications: 1.

E-mail: kik1092@mail.ru

В. М. Синєглазов, К. І. Каленюк. Система автоматизованого проектування світлодіодних світильників внутрішнього освітлення

Описано основні завдання, які розв'язуються під час проектування освітлювального приладу. Розглянуто принципи роботи з розробленим програмним забезпеченням для автоматизації процесу моделювання та проектування світлодіодного світильника.

Ключові слова: проблеми проектування; автоматизоване проектування; світлодіодні системи освітлення.

Синєглазов Віктор Михайлович. Доктор технічних наук. Професор.

Кафедра авіаційних комп'ютерно-інтегрованих комплексів, Національний авіаційний університет, Київ, Україна.

Освіта: Київський політехнічний інститут, Київ, Україна (1973).

Напрямок наукової діяльності: аеронавігація, управління повітряним рухом, ідентифікація складних систем, вітроенергетичні установки.

Кількість публікацій: 460.

E-mail: svm@nau.edu.ua

Каленюк Крістіна Ігорівна. Студент.

Кафедра авіаційних комп'ютерно-інтегрованих комплексів, Національний авіаційний університет, Київ, Україна.

Освіта: Національний авіаційний університет, Київ, Україна.

Напрямок наукової діяльності: енергетика, системи автоматизованого проектування.

Кількість публікацій: 1.

E-mail: kik1092@mail.ru

В. М. Синеглазов, К. И. Каленюк. Система автоматизированного проектирования светодиодных светильников внутреннего освещения

Описаны основные задачи решаемые при проектировании осветительного прибора. Рассмотрены принципы работы с разработанным программным обеспечением для автоматизации процесса моделирования и проектирования светодиодного светильника.

Ключевые слова: проблемы проектирования; автоматизированное проектирование; светодиодные системы освещения.

Синеглазов Виктор Михайлович. Доктор технических наук. Профессор.

Кафедра авиационных компьютерно-интегрированных комплексов, Национальный авиационный университет, Киев, Украина.

Образование: Киевский политехнический институт, Киев, Украина (1973).

Направление научной деятельности: аэронавигация, управление воздушным движением, идентификация сложных систем, ветроэнергетические установки.

Количество публикаций: 460.

E-mail: svm@nau.edu.ua

Каленюк Кристина Игоревна. Студент.

Кафедра авиационных компьютерно-интегрированных комплексов, Национальный авиационный университет, Киев, Украина.

Образование: Национальный авиационный университет, Киев, Украина.

Направление научной деятельности: энергетика, системы автоматизированного проектирования.

Количество публикаций: 1.

E-mail: kik1092@mail.ru